



# 2024

## PRODUCT CATALOG



QUALITY EQUIPMENT **SINCE 1933**





# **KELLY TRACTOR**

## **LETTER FROM THE PRESIDENT**

Dear Kelly Tractor Customer,

Empowering our customers to build stronger communities has been the cornerstone of our business since our inception in 1933.

From excavators to dozers to cranes, tools used in the construction trades, farm tractors and high-end material handlers, Kelly Tractor is proud to represent the product solutions you need to help you get the job done. Our world-class equipment manufacturing partners include Kalmar, Mitsubishi, Massey Ferguson, Fendt, Wacker Neuson, Magni and Link-Belt Cranes, to name a few.

To bolster your day-to-day productivity, we employ a dedicated product support team ready to provide you with the quality parts and service necessary to minimize downtime and maximize your business' profitability. In addition, as we cultivate our 91-year history as a full-service dealership, we proudly support the technicians of tomorrow by making generational investments for young people to pursue a technical career pathway in the industries we serve.

Today, guided by our longstanding commitment to ensuring your success as your trusted solutions provider, we are proud to share this equipment catalog tailored to guide you to find superior equipment and work tool solutions fundamental to your business needs.

Our focus in an increasingly competitive industry is to deliver an exceptional customer experience by enforcing a principle at the heart of our organization since our founding: "honest and fair dealing." To this end, we understand the importance of standardizing an appreciated, secure and effortless experience for you, our valued customer, in every interaction with us.

Always here to ensure your success,

Sincerely,



Chris Kelly  
Kelly Tractor Co. | President



# KELLY TRACTOR

www.kellytractor.com

Quality you Can Trust

Product Line



**WACKER  
NEUSON**



**Sullivan  
Palatek**



**Genie**  
A TEREX BRAND



**ABI  
irrigation**



**JUNGHEINRICH**

**SULLAIR**  
A Hitachi Group Company



**AISLE  
MASTER**  
LIFTING INNOVATION

**CAT** Lift  
Trucks

**HARLO**  
PRODUCTS  
MATERIAL HANDLING DIVISION



**RoGator  
TerraGator**



**MARDEN  
INDUSTRIES**

**MAGNI**  
TELESCOPIC HANDLERS

**KALMAR**

**FENDT**

**MITSUBISHI  
FORKLIFT TRUCKS**

**ROME**



**BLACKHAWK**

**SMITH  
CHALLENGER**  
MANUFACTURING & SERVICES, INC.



**Degelman**

**FELLING  
TRAILERS**



**Atlas Copco**

**IMT**  
INTERNATIONAL

**Bush-Whacker**  
TOUGH ON GRASS, EASY ON YOUR WALLET

**LEDWELL**  
1946 75 2021

**INTERSTATE**

**LAYMOR**

**WEILER**

**TOWMASTER  
TRAILERS**

**XL** SPECIALIZED  
TRAILERS

**HYDREMA**

## Table Of Contents

### CAT® PRODUCT LINE

Articulated Trucks .....	1
Backhoe Loaders .....	1
Asphalt Pavers / Screeds .....	2
Cold Planers / Reclaimers / Scrapers .....	3
Skid Steer / Multi Terrain Loaders .....	4
Telehandlers .....	4
Wheel Loaders .....	5-6
Track Excavators .....	7-8
Hyd. Mining Shovels / Material Handlers .....	9
Wheel Excavators .....	9
Rollers / Compactors .....	10-11
Moto Graders / Off-Highway Trucks .....	12
Bulldozers .....	13
Wheel Dozers .....	14
Pipelayers / Rotary Drills .....	14
Attachments .....	15
Caterpillar Merchandize .....	16
Safety Work Boots and Shoes .....	17

### METSO AGREGATE EQUIP.

Mobile Scalping Screen .....	18
Mobile Impact Crushers .....	18
Mobile Jaw Crushers .....	18

### WACKER EQUIPMENT

Vibratory Plates / Rammers .....	19-20
Internal Vibrators .....	21
Flexshafts / Vibrator Heads .....	22
External / Backpack Vibrators .....	23-24
Fastening Systems .....	24
Trowels .....	25
Vibratory Screeds .....	26
Vibratory Rollers .....	27
Dumpers .....	28
Light Towers .....	29
Light Balloons .....	30
Portable Generators .....	31
Mobile Generators .....	32
Pumps .....	33

### SULLAIR

Portable Compressors .....	34
----------------------------	----

### SULLIVAN PALATEK

Portable Compressors .....	35
Construction Air Tools .....	36

### ATLAS COPCO

Small Towable Air Compressors .....	37
Medium-Sized Air Compressors .....	38
Large Low/High Pressure Compressors .....	39
Small Vehicle Mounted Compressors .....	40

### ETNYRE PAVING PROD.

Asphalt Distributors .....	41
----------------------------	----

### HYDREMA

Articulated Dump Trucks .....	42
Articulated Water Tanker .....	43

### WEILER PAVING PROD.

Compact Paving Prod .....	44-46
Motor Grader .....	47

### XTREME MANUF.

Telehandlers .....	48
--------------------	----

### LAYMOR

Sweepers .....	49
----------------	----

### SMITH CHALLENGER

Brooms & Sweepers .....	50-52
-------------------------	-------

### SUPERTRACK

Forestry Tractors .....	53
-------------------------	----

### MAGNI

Telescopic Handlers .....	56
---------------------------	----

### LINK-BELT

All Terrain Cranes .....	57
--------------------------	----

Telescopic Truck Cranes .....	58
-------------------------------	----

Rough Terrain & Telescopic Crawler Cranes .....	59
---	----

Lattice Crawler Cranes .....	60
------------------------------	----

### IMT

Drill Rigs .....	61
------------------	----

### LIFT TRUCKS

CATERPILLAR	
-------------	--

Electric Lift Trucks .....	62
----------------------------	----

IC Cushion Tire Lift Trucks .....	63
-----------------------------------	----

IC Pneumatic Tire Lift Trucks .....	64
-------------------------------------	----

Hand Pallet Jacks .....	65
-------------------------	----

### mitsubishi

Electric Lift Trucks .....	67-69
----------------------------	-------

IC Pneumatic Tire Lift Trucks .....	70
-------------------------------------	----

IC Cushion Tire Lift Trucks .....	71
-----------------------------------	----

Hand Pallet Jacks .....	71
-------------------------	----

### JUNGHEINRICH

3 & 4 Wheel Elect. Lift Trucks .....	72
--------------------------------------	----

Vertical Order Pickers .....	73
------------------------------	----

Reach Trucks / Stand-On Stackers .....	74
--	----

Electric Pallet Trucks / Walkie Riders .....	75
--	----

### aisle MASTER

Narrow Aisle Forklifts .....	77-78
------------------------------	-------

### KALMAR

Large Capacity Forklifts .....	79
--------------------------------	----

Empty Container Handlers .....	80
--------------------------------	----

Loaded Container Handlers .....	81
---------------------------------	----

Reachstackers .....	82
---------------------	----

### HARLO PRODUCTS

Rough Terrain Forklifts .....	83
-------------------------------	----

### JLG ARIAL EQUIPMENT

Engine Powered Boom Lifts .....	85
---------------------------------	----

Electric & Hybrid Boom Lifts .....	86
------------------------------------	----

Electric & Rough Terrain Scissor Lifts .....	87
--	----

Stock Pickers / Towable Boom Lifts .....	88
--	----

Low - Level Access Lifts .....	89
--------------------------------	----

Vertical Lifts .....	90
----------------------	----

Drop Deck Trailers .....	91
--------------------------	----

### GENIE ARIAL EQUIPMENT

Telescopic & Articulated Boom Lifts .....	92
---	----

Electric & Bi-energy Booms Lifts .....	93
--	----

Slab & Rough Terrain Scissor Lifts .....	94
--	----

Work Platforms / Vertical Mast Lifts .....	95
--	----

Material lifts / Accessories .....	96
------------------------------------	----

Telehandlers & Attachments .....	97
----------------------------------	----

### LEDWELL

Water Trucks .....	98
--------------------	----

Box Dump Trucks .....	99
-----------------------	----

### AGRICULTURAL TRACTORS

MASSEY FERGUSON .....	101-104
-----------------------	---------

FENT .....	105-109
------------	---------

ROGATOR / TERRAGATOR .....	110-111
----------------------------	---------

### AGRICULTURAL ATTACHMENTS

MARDEN IND. - Forestry Implements .....	100
---	-----

WOODS - Cutter/Mower/Scrapers/Digger .....	112-113
--	---------

BUSH-WHACKER - Brush Cutters .....	114-117
------------------------------------	---------

DIAMOND - Booms / Mowers / Cutters .....	118-119
--	---------

ROME - Disk Harrows .....	120
---------------------------	-----

ABI IRRIGATION - Hose Reels / Booms .....	121-122
---	---------

DEGELMAN - Tillage/Rollers/Rock Rem .....	123-125
---	---------

### TRAILERS

BLACKHAWK (ETNYRE) .....	126-128
--------------------------	---------

TOWMASTER TRAILERS .....	129-131
--------------------------	---------

FELLING TRAILERS .....	132-136
------------------------	---------

INTERSTATE .....	137
------------------	-----

XL SPECIALIZED .....	138-139
----------------------	---------

### PRODUCT SUPPORT

Parts and Service Information .....	140
-------------------------------------	-----

### USED EQUIPMENT

Used Equipment Information .....	141
----------------------------------	-----

### CREDIT APPLICATION

Used Equipment Information .....	142-143
----------------------------------	---------



## CATERPILLAR PRODUCT LINE

The Cat equipment product line, consisting of more than 300 machines, sets the standard for our industry. We plan to help you meet your needs with our equipment, with our distribution and product support system, and the continual introduction and updating of products.

### • Articulated Trucks

Cat® articulated trucks haul a wide spectrum of material in a variety of applications and ground conditions. Simple operation and automotive style comfort along with combined service points and extended service intervals mean these dump trucks let you focus on your work spending less time and money on servicing.



745



740EJ

Model	Net Power (hp)	Engine	Capacity (ton)
725C2	314	Cat® C9.3	26.5
730	367	Cat® C13	31.0
730EJ	367	Cat® C13	30.0
735	424	Cat® C13	35.3
740EJ	496	Cat® C18	42.0
740GC	439	Cat® C15	40.0
745	496	Cat® C18	45.2



416F2



420F2 IT

### • Backhoe Loaders

Cat® Backhoe Loaders provide superior digging, trenching, back-filling and material handling capability and can be used for many applications, including but not limited to General Construction, Demolitions and Excavations, Landscaping, Breaking Asphalt and Paving. Cat backhoes deliver the power and precise handling you need when operating in areas where using larger equipment is not practical. Because of their relatively small frame size and versatility our backhoe loaders improve construction productivity and lower your machine operating costs. Select a Cat Backhoe Loader to best meet your needs today.

Model	Net Power (hp)	Operating Weight (lb)	Dig Depth (ft)
415F2	68	24251	14.3
415F2IL	68	24251	14.3
416F2	87	24251	14.3
420F2/420F2 IT	93	24251	14.3
430F2/430F2 IT	108	24251	15.4
440	104	29321	17.2
450	131	29321	17.0



## ASPHALT PAVING MACHINES

Caterpillar offers a broad range of asphalt paving equipment that competes in the rubber tire, steel track and rubber belted markets. Pavers and windrow elevators provide versatile and reliable solutions to demanding paving applications.

### • Track Asphalt Pavers

Track-equipped asphalt pavers offer superior traction for jobs that require wide pulls or large mix-delivery vehicles.

The exclusive Mobil-Trac™ System provides the best of both worlds by combining high tractive effort with rapid mobility.

Model	Gross Power	Operating Tractor Weight (lb)	Standard Paving width (ft)
AP355	74.8	19246	5.9-11.2
AP555	142.0	30430	8.4-16.4
AP655	173.0	34356	8.4-16.4
AP1055	225.0	45090	9.10-19.6



AP1055



AP355



AP500

### • Wheel Asphalt Pavers

Wheel-equipped asphalt pavers offer superior jobsite mobility for applications that require a lot of paver movement and relocation.

Provide rapid mobility and a smooth ride. Tractive effort and flotation are the advantages of steel track pavers.

Model	Gross Power	Operating Tractor Weight (lb)	Standard Paving width (ft)
AP300	73.8	18078	5.6-11.1
AP500	142.0	29020	8.4-16.4
AP600	173.0	30522	8.4-16.4
AP1000	225.0	41985	9.10-19.6

### • Screeds

CAT® asphalt screeds feature hydraulic variable-width adjustment and electrically heated screed plates. They are available in rear-extender and front-extender models.

Designed and sized for a variety of applications and operator preferences, ranging from fixed-width paving to hydraulically adjustable extenders.

#### Vibratory Screed

Model	Standard Paving Range (ft-in)	Max Paving Width (ft-in)	Standard Width (lbs)
SE50V	8.4-16.4	21	7239.0
SE60V	9.10-19.6	25'0"	7495.0
SE60V XW	9.10-19.6	33'0"	8973.0

#### Tamper Bar Screed

Model	Standard Paving Range (ft-in)	Max Paving Width (ft-in)	Standard Width (lbs)
SE50VT	8.4-16.4	26	7363.0
SE60VT XW	10-19.6	33'0"	9898.0



SE50 V



SE50 VT



## • Cold Planers

Cat® Cold Planers put the tons in the trucks hour after hour, shift after shift. Production is not just about horsepower. It's how the cold planer delivers the power to the rotor. Cat rotor drive systems are the most efficient and the best-protected in the industry. Cat load control provides the most responsive system, always keeping engine speed close to peak torque when the cutting gets tough. Cat cutter bits last longer to boost uptime and ultimately production. Clean milled surfaces are left behind due to precise control of moldboard pressure. Cat Grade and Slope option is available

Model	Milling Width	Rated Power (hp)	Operating weight
PM310	39.4	325.0	47746
PM312	48.2	325.0	48153
PM313	51.2	325.0	48382
PM620	79.1	630.0	73260
PM622	88.0	630.0	74580
PM820	79.1	800.6	79630
PM822	88.0	800.6	80887
PM825	98.6	800.6	82650



PM313

## • Road Reclaimers

Cat road reclaimers pulverize the asphalt layer and mix it with the underlying base to stabilize deteriorated roadways. The reclaimers can add asphalt emulsions or other binding agents during pulverization or during a separate mix pass.

They can add asphalt emulsions or other binding agents during pulverization or during a separate mix pass or cut, mix and pulverize native in-place soils with additives or aggregates to modify and stabilize the soil for a strong base. Two cutting depths are available for each machine to match job requirements.

Model	Gross Power (hp)	Max Operating Weight (lbs)	Cutting/Mixing Width (in)
RM300	350	53911	96.0
RM500B	546	62611	96.0



RM300



RM500B

## • Wheel Tractor - Scrapers

Cat® wheel tractor-scrapers have the power, traction, and speed for reliable output in a variety of earthmoving applications. Scraper options include single-engine and tandem-engine open bowls, tandem engine push-pulls and elevator arrangements.

Model	Gross Power (hp)	Max Operating Weight (lbs)	Capacity (yd³)
621K	407	79787	24.0
627K	407	90213	24.0
631K	462 / 500	102750	34.0
637K	462 / 500	119060	34.0
657G	564 / 600	n/a	44.0



627K



631K



## • Skid Steer Loaders

Cat® Skid Steer Loaders are designed and built for maximum performance and safety. We are constantly developing and refining advanced power and hydraulic technologies to ensure that our Skid Steer Loaders provide customers with the power, versatility, efficiency, ease of operation and reliability they have come to expect from - Cat® Equipment.

The Cat® Skid Steer Loader, with its many work tool options, is ideal for construction, landscaping, agriculture and other applications.

Model	Gross Power (hp)	Operating Weight (lbs)	Operating Capacity (lbs)
226D3	67.1	5849	1550
232D3	67.1	6514	1900
236D3	74.3	6567	1800
242D3	74.3	7138	2200
246D3	74.3	7478	2200
262D3	74.3	8296	2700
272D3	98.0	9133	3450
272D3 XE	110.0	9573	3700



262D3



259D3



257D3

## • Compact Track And Multi Terrain Loaders

Cat® Compact Track Loaders and Multi Terrain Loaders feature suspended undercarriages for lower ground pressures and superior traction. Spacious, ergonomic operator station and easy-to-use pilot operated joystick controls keep you comfortable throughout the workday. High performance power train, advanced hydraulic system, traditional Cat reliability and a wide range of Cat Work Tools improve your productivity in the toughest working conditions.

Model	Net Power (hp)	Operating Weight (lb)	Operating Cap. 35% Tipping load (lbs)	Tipping Load
<b>Compact Track Loaders</b>				
239D3	67.1	7434	2185	4370
249D3	67.1	7831	2485	4970
259D3	74.3	8987	2870	5745
279D3	74.3	10095	2220	6345.00
289D3	74.3	10688	2890	8255.00
299D3	89.0	11464	3480	9945.00
299D3 XE	110.0	11756	3560	10170.00
<b>Multi Terrain Loaders</b>				
257D3	74.3	8094	1800	5145

## • Telehandlers

Telehandlers are the best machines where lift and reach are combined. By simply exchanging the forks with other work tools, these machines will operate all day and in all phases of work. Their versatility and high performance will increase productivity and reduce the investment needed for the purchase of additional specialty equipment.

Model	Power (hp)	Op. Weight (lbs)	Rated Cap. (lbs)	Lift Height
TH255C	74.0	11000	5500	18.37
TL642D	100.0	22002	6500	42.00
TL943D	111.3	26852	9000	43.00
TL1055D	142.1	34160	10000	54.90
TL1255D	142.1	34361	12000	54.60



TH255C





## • Compact Wheel Loaders

Wheel loaders are among the most versatile equipment we make and the customers who use them have one thing in common, they're looking for maximum uptime. We're continually investing in research and development so that our wheel loaders perform the way our customers need them to.

The machine's mobility and smooth shifts make for greater operator confidence and faster cycle times. When used with a Quick Coupler, a wide variety of work tools can be easily added for maximum versatility in multiple applications.

Cat® Compact Wheel Loaders provide superior performance and versatility to help your customers get more done. Built to the same tough standards as the larger Cat Wheel Loaders, these machines are ideal for a wide range of jobs and applications.

A wide range of work tools is also available for even greater machine versatility.

Model	Net Power (hp)	Operating Weight (lbs)	Bucket Capacity (yd3)
903D	42.0	9414	0.8-1.3
906M	73.0	12346	1.0-1.6
907M	73.0	12677	1.0-1.6
908M	73.0	14032	1.2-2.0
910	110.0	18102	1.3-1.9
914	110.0	19103	1.3-1.9
920	121.0	21742	1.3-1.9



906M

## • Small Wheel Loaders

The all new Cat® M Series Small Wheel Loaders (924M, 926M, 930M and 938M) are designed to deliver class-leading comfort, performance and fuel efficiency. The optimized Z-bar loader linkage delivers the performance and breakout forces of a traditional Z-bar linkage with the parallelism and load handling capability of a tool carrier. The M Series models feature the Cat C7.1 ACERT engine which meets Tier 4 Final / Stage IV emissions standards.



926M



930M



938M

Model	Net Power (hp)	Operating Weight (lbs)	Bucket Capacity (yd3)
926M	168.0	28193	1.9-5.0
930M	168.0	31382	2.1-5
938M	188.0	41794	3.0-5



## • Medium Wheel Loaders

Cat® Medium Wheel Loaders provide customers with the most reliable, productive and comfortable wheel loaders in the industry, built to tackle a wide range of jobs.

From material handling and truck loading, general construction or stockpiling, Cat® medium wheel loaders are ready for your work. Spacious cabs and low effort controls ensure a comfortable and productive environment. Their reliability, durability and versatility result in front loaders that are built for your success.



950M

Model	Net Power (hp)	Operating Weight (lbs)	Bucket Capacity (yd3)
950GC	225.0	41554	3.75-5.75
950M	230.0	42357	3.3-12
962M	250.0	44591	3.3-12
966M	276.0	51776	4.19-9.68
972M	299.0	54871	4.19-13
980M	380.0	66337	5.25-16
982M	436.0	78402	6.0-15.75



## • Large Wheel Loaders

Cat® Large Wheel Loaders are designed with durability built in, ensuring maximum availability through multiple life cycles. By optimizing performance and simplifying serviceability, our machines move more material efficiently and safely at a lower cost per ton.

Cat® Large Wheel Loaders set the standard for optimized productivity, minimizing downtime, enhancing operator comfort, and protecting people on your jobsite through key safety features.



992K



986K



988K

Model	Net Power (hp)	Operating Weight (lbs)	Bucket Capacity (yd3)
986K	373.0	98806	6.5-13.5
988K	541.0	112574	6.2-17
990K	699.0	178517	9.7-19.5
992K	814.0	220089	14-16
993K	973.0	294687	16-31
994K	1,739.0	534852	25-32

# KELLY TRACTOR



CAT®

## • Mini Excavators

The extensive line of Cat® Mini Hydraulic Excavators offers performance to dig in and be productive on every job. Whether looking for transportability, efficiency or performance, you can offer the right solution to any customer.

Model	Net Power (hp)	Op. Weight (lbs)	Dig Depth (in)
300.9D	13.0	2061	5.68
301.5	19.2	3898	100.00
301.7 CR	19.2	4063	100.00
301.8	19.2	4442	101.20
302 CR	19.2	4861	101.20
302.7D CR	20.7	6239	N/A
303E CR	23.5	7204	117.00
303.5E2 CR	23.5	8209	125.00
304E2 CR	40.2	8996	135.00
305E2 XTC	40.2	8996	135.00
305.5E2 CR	44.1	11958	152.00
306 CR	55.9	15821	162.00
307.5	55.9	18152	183.00
308 CR	70.3	20678	183.00
309 CR	70.3	20731	181.00
310	70.3	22447	205.00



305.5E2 CR



308 CR



316FL

## • Small Excavators

Cat small excavators are perfect for smaller jobs and applications with space constraints. Powered by fuel-efficient engines and advanced hydraulic systems, our small excavators offer exclusive Cat technology and a variety of matching Cat attachments to help you complete your work on time at a low cost per hour.

Model	Net Power (hp)	Op. Weight (lbs)	Dig Depth (ft)
311FL RR	71.0	28660	18.33
313F GC	70.0	29300	19.75
313FL	92.0	33080	19.80
315FL	97.0	37794	19.50
316FL	117.0	39029	20.00
318FL	117.0	42340	20.00

## • Medium Excavators

Their size make Cat® mid-size excavators easy to transport to the jobsite. With ample power, exclusive factory-equipped technology, comfortable cabs, simple maintenance and matching Cat attachments, Cat mid-size excavators will help you complete larger projects at a lower cost.

Model	Net Power (hp)	Op. Weight (lbs)	Dig Depth (ft)
320 GC	121.0	48281	22.00
320	162.0	50265	22.10
323	162.0	56200	22.10
325	172.0	49604	22.00
326	201.0	57100	22.38
330 GC	202.0	67700	23.80
330	273.0	68100	23.80
335FL	200.0	83820	22.93



325



CAT®

## • Large Excavators

Their power, speed, and fuel efficiency make Cat® large excavators the right machine for bulk excavation applications. within budget.

With powerful, yet efficient engines, advanced hydraulic systems, factory equipped technology, and matching attachments, these machines will help you complete your large-scale projects on time and

Model	Net Power (hp)	Op. Weight (lbs)	Dig Depth (ft)
336 GC	273.0	80500	27.00
336	311.0	81900	26.90
349F	417.0	107145	25.17
352F	417.0	112200	24.67
374F	472.0	161533	23.67
390F	524.0	198070	23.50



390F

## Demolition Excavators

Cat® demolition excavators are purpose built for the rigor of demolition applications. With specialized cabs, straight boom and ultra high reach configurations, and a full line of matching demolition attachments, Cat demolition excavators are ready to help you tear through your next job.



340

340F UHD

Model	Net Power (hp)	Op. Weight (lbs)	Dig Depth (ft)
340	314.0	87900	21.80
340F UHD	313.0	112215	71.20

## • Long Reach Excavators

Get the job done in tough, hard-to-reach places with Cat long reach excavators.

The Long Reach Excavation Hydraulic Excavator is built to keep your production numbers up and your owning and operating costs down. Where the real power comes in is through the hydraulic system. You can literally move tons of material all day long with a great deal of speed and precision. You simply won't find better Long Reach Excavation machines.

Model	Net Power (hp)	Op. Weight (lbs)	Dig Depth (ft)
340	311.0	96700	42.80
352 LRE	408.0	130955	N/A



352 LRE

# KELLY TRACTOR



CAT®

## • Hydraulic Mining Shovels

Proven success in nearly every surface mining application across the globe substantiates the durability and reliability of Cat® hydraulic shovels.

Utilizing proven Cat technology, each hydraulic shovel in our line-up is designed to provide superior digging forces and fast cycle times for the highest levels productivity. With the widest payload range in the industry, and the ability to pair each with Cat minir trucks, Caterpillar is well-equipped to fulfill a hydraulic shovel need.



6015B



6040 FS

Model	Net Power (hp)	Op. Weight (ton)	Bucket Payload (ton)
6015	824.0	154.3	16.1
6020B	1,040.0	253.8	23.8
6030	1,620.0	324.0	33.0
6040	2,079.0	446.0	43.7
6060	3,023.0	660.0	67.0

## • Wheel Excavators

Cat® wheel excavators have the mobility, speed, power and reliability to be the most versatile machine in your fleet. Visit your Cat dealer to find out why Caterpillar is the global leader in wheel excavators.



M315

Model	Net Power (hp)	Max Operating Weight (lbs)	Max Travel Speed (mph)
M314	134	39700	23
M315	148	39700	19
M316	148	40600	22
M318	174	43900	22
M319	174	46400	22
M320	174	46700	22
M322	174	52900	19

## • Material Handlers

Cat® material handlers have been designed and built for your demanding industry. These aggressive machines deliver fast, mobile, efficient performance whether equipped with a grapple, clamshell bucket or magnet.

Model	Net Power (hp)	Max Operating Weight (lbs)	Max Travel Speed (mph)
MH3022	169.0	50552.0	16.0
MH3024	169.0	53242.0	16.0
MH3026	169.0	57651.0	16.0



MH3022



## • Landfill Compactors

Cat® landfill compactors have enhanced features with additional guarding and attention to placement of components to ensure you get the most durable landfill compactor.

Caterpillar offers three sizes of landfill compactor to meet small, medium and large customer needs. The 816K, 826K and 836K are all purpose-built and designed for this challenging application.



816K



836K

Model	Gross Power	Net Power (hp)	Operating weight (lbs)
816K	284.0	248.0	56899
826K	435.0	405.0	90207
836K	562.0	496.0	123319



CW34

## • Pneumatic Rollers

Cat Pneumatic Rollers are ideal for applications like wear courses and binder courses as well as compaction of natural soils and materials with lime or cement.

Model	Gross Power	Compaction Width (in)	Operating weight (lbs)
CW34	133.0	82.0	22050
CW16 9 Wheel	100.5	68.0	11464
CW16 11 Wheel	100.5	84.0	11685

## • Soil Compactors

When Cat Soil Compactors are part of your operation, you will know firsthand why they are the industry standard for high-speed, self-propelled, non-vibratory tamping-wheel compactors. They are fast enough in the fill area to keep up with a scraper or articulated truck fleet and help meet the tight job schedules. When you add in their reliability and low operating costs, it is easy to see why "leadership in value" is their reputation.

The purpose-built Cat® four-wheel drive soil compactors maximize soil density through a tamping wheel tip design, machine weight impact and higher speeds for greater penetration.



815K



825K

Model	Net Power (hp)	Operating weight (lbs)	Bore (in)
815K	248.0	48740.0	4
825K	405.0	78326.0	5



## • Tandem Vibratory Rollers

Cat Tandem Vibratory Rollers are available in a range of sizes and configurations to meet any application. Large double-drums are simple to set up for maximum compaction efficiency on any type of mix.

Model	Gross Power (hp)	Op. Weight (lbs)	Standard Comp. Width (in)
CB1.7	24.7	3,538	35
CB1.8	24.7	3,825	39
CB2.5	48.2	5,546	39
CB2.5GC	24.6	5,546	39
CB2.7	48.2	5,936	47
CB2.7GC	24.6	5,936	47
CB2.9	48.2	6,415	51
CB4.0	48.2	7,971	51
CB4.4	48.2	8,362	55
CC2.7	48.2	5,718	47
CC2.7GC	24.6	5,718	47
CC4.0	48.2	7,889	51



CB2.5



CB2.7



CS34

## • Vibratory Soil Compactors

Cat Vibratory Soil Compactors are durable and reliable. They offer high compaction performance, speed and gradeability to maximize productivity on a wide range of applications.

The Cat® Soil Compactor family includes a broad selection of productive and reliable models with smooth or padded drums. Cat soil compactors achieve excellent results on a wide range of materials and applications. The combination of horsepower, weight and balance result in the stability, power and traction required for continuous, high-capacity operation.



CS56B

Model	Gross Power (hp)	Op. Weight (lbs)	Standard Comp. Width (in)
CS10GC	120.7	23136.0	84
CS11GC	120.7	24775.0	84
CS12GC	120.7	27900.0	84
CS34B	74.0	9799.0	54
CS44B	100.6	15895.0	66
CS54B	131.0	23265.0	84
CS56B	157.0	25346.0	84
CS64B	131.0	26569.0	84
CS68B	157.0	31572.0	84
CS74B	173.7	35264.0	84
CS78B	173.7	41214.0	84



CAT®

## • Motor Graders

The motor grader is one of the most versatile machines in the Cat® product line. Cat motor graders are used in numerous applications within a wide range of industries. This broad line allows the customer to choose a motor grader that best fits the intended application.

The major industries using Cat motor graders are heavy construction, governmental, building construction, industrial, mining and forestry. Typical applications within each industry includes finish grading, heavy blading, site preparation, road maintenance, side/bank slope work, ditch building/cleaning, ripping/scarifying and snow removal.



14



120

Model	Net Power (hp)	Operating Weight (lbs)	Standard Blade Length (ft)
120 / 120 AWD	139	35,067	12
140 / 140 AWD	179	42,647	12
140 / 140 AWD LVR	250	42,325	12
150 / 150 AWD	200	43,950	12
160 / 160 AWD	221	45,547	14
14	238	57,250	14
16	290	71,454	16
18	304	74,324	18
24	535	161,695	24

## • Off-highway & Mining Trucks

For over 50 years, rugged Cat® off-highway trucks and mining trucks have worked in the harsh conditions of mines, construction projects and quarries around the world. Paired with our wheel loaders and excavators, you can count on our haul trucks for maximum productivity at a low cost per ton.

Cat Mining Trucks are engineered for performance, designed for comfort and built to last. These powerful haul trucks can move more material at a lower cost.



785D



777G



777G

Model	Gross Power (hp)	Nominal Payload (ton)	Operating Weight (lbs)
770G	477.0	42.1	157000
772G	550.0	51.6	181000
773E	672.0	61.0	219000
773G	717.0	61.0	226503
775G	768.0	70.5	246503
777G	916.0	98.4	363000
785D	1,450.0	157.0	550000





## • Small Bulldozers

Under 105 hp, the Cat® small dozers are designed to optimize speed, transportability, maneuverability, versatility and finish grading accuracy. These crawler dozers are ideal for residential construction performing such tasks as clearing and grading lots, sloping the sides of roads, back-filling, and final grade work for landscaping and driveway construction.



D1



D3

Model	Old Model	Net Power	Op. Weight	Blade Capacity (yd <sup>3</sup> )
D1	D3K	80.0	18390	2.17
D2	D4K	92.0	19019	2.59
D3	D5K	104.0	21150	3.06

## • Medium Bulldozers

Cat® bulldozers help you move more material in less time. Fuel efficiency and features to make service and maintenance easier help you reduce your overall dozer owning and operating costs. Plus, factory integrated GRADE technology features help get work done even faster, from first pass to finish grade.



D6

Model	Old Model	Net Power	Op. Weight	Blade Capacity (yd <sup>3</sup> )
D4	D6K	130.0	29258	4.98
D5	D6N/D5R	172.0	38228	5.60
D6	D6T/R	219.0	48500	7.50
D7	D7E/R	238.0	57441	8.98
D8	D8T/R	354.0	87600	13.40

## • Large Bulldozers

Cat® large dozers are designed for tough working conditions. Elevated sprockets increase productivity, simplify maintenance, reduce downtime with modular components and raise final drives and associated power train components out of the work environment. Cat mining dozers keep material moving with the reliability and low operating costs.

From large to small, mining to finish work, you are certain to find a Cat® Dozer to match your needs. See your Cat dealer for advice on matching the right machine to your needs.



D9



D10



D11

Model	Old Model	Net Power	Op. Weight	Engine
D9	D9T/R	436.0	106618	Cat® C18
D10	D10T2	600.0	154700	Cat® C27
D11	D11T	850.0	229800	Cat® C32



## • Wheel Dozers

Built in Aurora, Illinois, Cat®, Wheel Dozers are a versatile tool in mining, coal fired power plants and with custom attachments like the scoop blade, able to move lightweight materials like wood chips quickly and economically.

Every operation is looking for high production support machines. Cat wheel dozers combine the production capabilities of track-type tractors with the mobility and versatility of wheel loaders to give you an outstanding utility machine.

Model	Net Power	Op. Weight	Engine
814K	248.0	48390	Cat® C7.1
824K	405.0	74966	Cat® C15
834K	496.0	105271	Cat® C18
844K	752.0	165089	Cat® C27
854K	907.0	224254	Cat® C32 ACERT



824K

## • Pipelayers

Cat® pipelayers have been the standard of the pipelining industry for decades. A worldwide network of Cat dealers, in tune with the special high production needs of pipeliners, supports these durable, dependable machines.



PL83

Model	Lift Capacity (lbs)	Flywheel Power (hp)	Engine
PL61	40,000	130.0	Cat® C4.4
PL72	90,000	212.0	Cat® C9.3
PL83	170,000	319.0	Cat® C15
PL87	216,000	319.0	Cat® C15

## • Rotary Drills

Building on the solid legacy of proven designs, today's Cat® Rotary Blasthole Drills offers substantial technology, efficiency and productivity improvements to efficiently reach your targeted productivity rates. Our newest models fully integrate Cat designs, components and technologies, and every model delivers exactly what you expect from a product bearing the Cat brand: durability, precision, productivity, and unmatched parts and service support, anywhere in the world. It's what lies beneath the paint that counts — that's where you'll find everything we stand for.

Model	Bit Load (lbs)	Hole Diameter (in)	Engine
MD6200	37,400.0	5.0-7.87	Cat® C18 ACERT
MD6250	71,993.0	6.0-9.80	Cat® C27 ACERT
MD6310	92,922.0	8.0-12.25	Cat® C32 ACERT
MD6540C	118,719.0	9.0-16.00	Cat® 3512 HD
MD6640	141,096.0	9.6-16.00	N/A



MD6200



## • Attachments

Attachments tailor Cat machines to the specific requirements of a customer's working needs.

Caterpillar Attachments enhance the productivity and utility of Caterpillar machines, equipping them for a wide range of tasks and operating requirements, and providing total system solutions for any job application.



**AUGERS**



**AUGERS BITS**

Designed to drill holes for footings, fencing, signs and trees.



**HAMMERS**

Cat® hydraulic hammers make short work of your demolition, construction, quarry and production breaking needs.



**BACKHOES**

Cat® Backhoes are used in typical backhoe applications such as digging footings, basements, and drainage ditches, utility trenching, back-filling, and maintaining slopes and embankments in construction, industrial, and landscaping settings. They are ideal for demolishing concrete when paired with Cat H45/H55/H65 hammers.



**FORKS**

Cat® forks are the ideal choice for a wide variety of applications.

## BUCKETS

Cat® Buckets are used to dig, load, carry, level, dump and grade in a variety of applications.





CAT®

## • Caterpillar Merchandise

Genuine CAT® clothing, footwear, toys, scale models, accessories, and more.

Contact us for all official Caterpillar merchandise. Genuine Caterpillar apparel, footwear/shoes/boots, toys, scale models, accessories, and more.



HATS



OFFICE



MISCELLANEOUS



KIDS & LADIES



POLOS & T-SHIRTS



SCALE MODELS



DRINKWARE



WATCHES



BAGS & COOLERS



## • Safety Work Boots & Shoes

Cat® Footwear harnesses the strength and innovation of Caterpillar Inc., whose revolutionary technologies continue to transform the world around us. Inspired by the attitude of the equipment, our innovative and bold products defy limitations.

With each pair of shoes we sell, we're powering our earthmovers with the strength of machines.

Please contact us for a full line of Cat® Shoes availability and sizes.



SECOND SHIFT – P89162



REVOLVER – P72191



## • Steel Toe

Cat® Steel Toe boots and shoes are rated ASTM F2413-05 I/75, C/75 the highest available strength for impact and compression.

## • Composite Toe

Cat® footwear with Composite Safety Toes are rated ASTM F2413-05 and are non-metallic and undetectable in electronic security environments.

## • Alloy Toe

Cat® footwear with Advance Alloy Safety Toes are rated ASTM F2413-05 EH and are 50% lighter than traditional steel toe footwear while still protecting toes from impact and compression.



## AGGREGATE EQUIPMENT

Kelly Tractor Co is now an authorized distributor for Metso® Aggregate Mobile Crushing and Screening Plants, Cone Crushers, Gyratory Crushers, Impactors, screens and Jaw Crushers. At Metso®, we know that the real measure of our worth is the results we deliver to our customers.

- **Mobile Scalping Screen**

Mobile screens are a cost-effective and flexible way to screen material at your production site. Metso's wide range of Lokotrack® mobile screens provide excellent productivity in smaller aggregates production sites, larger quarries, and in mining applications.



ST2.8



LT1213

- **Mobile Impact Crushers**

Mobile impact crushers, or mobile impact crushing plants as they are also known, are easily movable and transferable crushing machines used to reduce the size of rocks and other materials in aggregates production, recycling applications, and in mining operations. Depending on the model, mobile impact crushers have either excellent reduction ratios or capabilities to produce precisely shaped cubical end products.

- **Mobile Jaw Crushers**

Mobile jaw crushers, or mobile jaw crushing plants as they are also called, are track-mounted crushing machines conventionally utilized as primary crushers in aggregates quarries, recycling applications and on construction sites, but also in mining operations. Mobile jaw crushers can be moved around at a production site on their own, without supporting equipment – or simply transported between locations.



LT106

**For more information on Metso Aggregate Equipment and full line of products**

Please contact Mike Wohlert (561)-373-1448 or email him at: [Mike\\_Wohlert@kellytractor.com](mailto:Mike_Wohlert@kellytractor.com)

Para Español, por favor llame a Melissa Lara (305) 592-0556 [ludwig\\_taverasperdomo@kellytractor.com](mailto:ludwig_taverasperdomo@kellytractor.com)



**WACKER  
NEUSON**

## BATTERY-OPERATED VIBRATORY PLATES - AP1840e, AP1850e

The battery-operated vibratory plate The AP1840e and AP1850e are the world's only battery-operated, cordless vibratory plate for completely emissions-free operation. With a battery run time that is enough for a full working day, these plates are an excellent choice for new commercial interior or renovation projects, poorly ventilated areas such as trenches and tunnels and projects with strict emission and noise guidelines. The simple operation and reliable compaction performance make the cordless plate an excellent rental machine. Available with and without a water tank.

- Large area compaction capacity, one battery charge last for a full working day
- Proven electric motor without V-belt is maintenance free
- Emission-free operation protects the operator on all construction sites and opens new fields of applications in the interior and in emission-regulated areas
- Same compaction performance as comparable gasoline powered vibratory plates
- Battery and charger are modular and can also be used for our battery rammers



**AP1840we**

## SINGLE DIRECTION VIBRATORY PLATES (50-110 Lbs.)



**WP 1550A**

Vibratory plates have set the standard for the industry in confined area compaction of sand, gravel and crushed aggregate, as well as hot and cold asphalt. These vibratory plates are ideal for backfill trenches, slab base preparation, curbs and gutters. Wacker plates can compact 10 to 40-inch lifts of soil.

- Lightweight, high-strength components keep machine weight down and allow for easy handling.
- Straight, center-mounted guide handle offers superior maneuverability and can be lowered within inches of the surface to operate the plate under obstacles and form work.
- Tough, wear resistant ductile iron base plate offers durability and shock resistance.
- Water tank models have a large capacity polyethylene tank that includes a large filter inside the tank to prevent clogging during operation and can be easily removed for cleaning and draining.
- Asphalt models include a spray bar with angled holes to allow for complete water coverage for no asphalt pick up on the plate bottom.



## WACKER NEUSON

### REVERSIBLE VIBRATORY PLATES

Reversible vibratory plates are ideally suited for compaction in confined spaces of granular and mixed soils such as utility trenches and along highways, dams, parking areas, airports, bridge construction, railroad beds, foundations, walls and abutments.

Our reversible vibratory plates are available in various sizes. Individual - just the way you need them. You can also get select models with remote control for a high level of operating comfort and sensitive variable control.



BPU 2540A



DPU 110



DPU6555Heh



DPU 130Le

### VIBRATORY RAMMERS

Vibratory rammers are ideal for compaction of cohesive, granular and mixed soils around foundations, columns, trench backfill, and wherever compaction is needed.

Now with the **AS50e** cordless, battery powered rammer ideal for indoor construction and renovation projects; for use in poorly ventilated areas including trenches as well as in sound sensitive areas such as hospitals. The battery is separate from the rammer and can be replaced in a few quick steps without special tools.



AS50e





## ELECTRIC INTERNAL VIBRATORS

Our extensive range of internal vibrators offers solutions with simple comfort for standard applications or the premium line for the highest professional requirements. The high-quality design guarantees an excellent quality for all model series.

- **Premium Line Internal Vibrators**

The high frequency internal vibrators with integrated converter offer a high level of operating comfort and maximum flexible handling. The internal vibrators can easily be connected to any conventional outlet without the need for additional accessories while maintaining the same high rpm and compaction quality.



### Modular System:



- **Advanced Line Internal Vibrators**

The classics among our internal vibrators. Our time-tested and proven machine concept, consisting of a motor that is installed in the vibrator head. In addition, there is the specially hardened vibrator head as well as an extremely sturdy power cable. This concept offers a long service life and an attractive price-performance ratio.

The high-frequency internal vibrators of the IEC series have an integrated internal vibrator and therefore offer two units in one. The internal vibrators are characterized by a high level of flexibility and easy handling. The ergonomics of the design and the price-performance ratio speak for themselves.





**WACKER  
NEUSON**

## Basic Line Internal Vibrators

The electrical driven HMS system is extremely versatile. These high frequency flex-shaft internal vibrators can be adapted to every type of application. Heads and shafts can be easily combined and rapidly exchanged to match the right equipment to the job. Unique hybrid heads offer optimum concrete consolidation and movement. Wacker Neuson internal vibrators provide reliable performance and quality concrete.



**M2500**

Individually configurable flexible shafts, vibratory heads and motors in various performance classes

- Electric Motors**

Model	Vibrations (rpm)	Engine / Motor	Voltage 1~ V	Current (A)	Frequency (Hz)	Power kW (hp)	Weight (lb)	L x W x H (in)	Power cable (ft)
M1500	14000	Double insulated universal motor	120	12.5	50 - 60	2	10.9	12.3 x 6.1 x 9.1	1.6
M2500	16000	Double insulated universal motor	120	15	50 - 60	2.5	11.9	12.3 x 6.1 x 9.1	1.6

- Vibrator Heads**

Model	Standard				Square				Rubber Coated			
	H 65	H 25S	H 35S	H 45S	H 25HA	H 35HA	H 45HA	H 50HA	HR48	HR65	HR70	HR70S
Diameter (in)	2.6	1	1.4	1.8	1	1.4	1.8	2	1.89	2.5	2.75	2.75
Length (in)	15.2	11.6	12.2	12	15	15.9	15.4	15.6	6	15	15	150
Weight (Lb)	13.7	1.8	3.5	6.2	2.9	5.1	7.3	8.5	6	8.4	11	6



- Flexshafts For Internal Vibrators**

Model	SM1-E	SM2-E	SM3-E	SM4-E	SM5-E	SM7-E	SM0-S	SM1-S	SM2-S	SM3-S	SM4-S	SM5-S	SM7-S	SM9-S
Length in	39.4	78.7	118.2	157.5	197	275.8	19.7	39.4	78.7	118.1	157.5	196.8	275.6	354.3
Weight lb	3.3	5.5	7.5	9.5	11	15.4	2.9	6	9.5	13	15.7	20.6	28.4	33.3

Flexshafts / Internal Vibrators / Vibrator Heads



**WACKER  
NEUSON**

## EXTERNAL VIBRATORS

### • Consolidation of in-situ Concrete

Major projects require a high quality of concrete consolidation. Our external vibrators make compacting in-situ concrete a breeze. Despite the compact dimensions and the light weight, the consolidation of large in-situ concrete areas is no problem at all.

Wacker Neuson external vibrators have been used for concrete consolidation for many years. The AR26 external vibrator was designed specifically for cast-in-place formwork as well as light precast concrete applications. Its low weight, compact size, and ability to keep a constant speed under load make it the preferred external vibrator for concrete consolidation worldwide.



AR26

External Vibrators

### • Concrete Consolidation in Prefabricated Concrete Factories

First-class concrete consolidation is crucial when it comes to producing concrete surfaces. For the consolidation of precast elements, we therefore offer you a series of first-class external vibrators that you can use to create wonderfully smooth and even surfaces on walls, columns or pillars.



- Extremely versatile thanks to its integrated frequency inverter
- Continuous duty thanks to its powerful, well designed electric motor
- Specially designed for cast-in-place jobsite applications or light precast
- Fast assembly thanks to easy to use fastening clamps
- Brushless asynchronous motor alleviates the need to change brushes
- LED operating indicator display and sealed grease bearings



ARFU26



## WACKER NEUSON

### FASTENING SYSTEMS

- **Fastening systems for external vibrators**

Wacker Neuson offers a variety of options to fix external vibrators to formwork. From flanges and taper pins to center bolts; we always have the right fastener for your site.

You will find the right fastening system for any external vibrator here. In this way, our external vibrators can be brought exactly to where you need them.



Saddle clamp  
with center bolt  
(for AR52)



SV 5

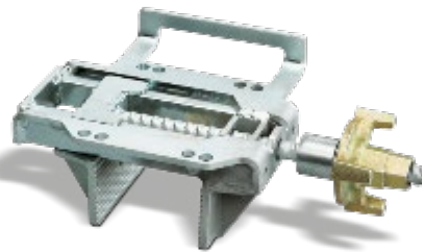

SV 55



AV 6

### BACKPACK VIBRATORS

- **Portable concrete consolidation with maximum results**

The portable gasoline vibrators with comfortable backpack features high impact, high speed concrete vibration. It is designed for light to medium duty concrete work and hard to reach concrete applications with limited electrical supply. Throttle mechanism can be moved on either side of the operator to suit individual operating preferences. Swivel engine mount keeps the center of gravity close to the operator.

- No power cords required - great for applications with limited access to electrical power.
- Harness system fits a variety of body profiles via seven-point adjustment including vertical height.
- Centrifugal clutch allows for easy starting in all applications.
- New version is lighter for improved ergonomics.
- Portable and productive - offering over 10,000 vibrations per minute.



BV50A-H





### • Electronic Frequency Converters

The outstanding feature of the FUE range of frequency converters is its lightweight, compact design. Thanks to their aluminum construction they are very easy to handle. Their high-quality electronics and active cooling system ensure maximum performance even in continuous operation. The intelligent voltage and power management is particularly practical. It compensates for fluctuations of mains input voltage, wrongly dimensioned extensions or appliances with greatly varying use of power.



- The FI protective switch is sensitive to pulsating currents. Therefore, the devices can be used practically anywhere.
- Maximum safety: Galvanic isolation with isolating transformer
- Maintenance-free
- Intelligent voltage and power management

True lightweights. These frequency converters are easy to transport. And therefore, flexibly deployable: The compact dimensions and an extremely light weight make transport easy.





## WACKER NEUSON

### VIBRATORY SCREED

When finishing concrete slabs, Wacker Neuson's wet screed can fit the demands of every job site with a variety of blade lengths, plus each unit is designed to fit the demands of every operator. Its unique twin handle system is fully height and angle adjustable offering maximum operator comfort. In addition, two isolators and specialized lower handle mount design reduce vibration to the operator. The squeeze grip handle is also foldable for easy transport and storage.



P35A



- Adjustable eccentric weights can be adjusted to seven different positions allowing the unit's force to be appropriately matched to the application.
- Lightweight unit features lifting handle for easy transport.
- High production unit for quick and accurate strike-off of concrete slabs with or without the support of grade stakes and forms.
- Fully enclosed exciter for operator production and low maintenance.



## VIBRATORY ROLLERS

- Tandem Rollers**

To be able to offer you the right machine for any type of ground, the ride-on and walk-behind tandem rollers are available in various sizes and performance levels. Compacting asphalt, coarse gravel and other types of ground and sub-surfaces is therefore no problem for our rollers.

**The All New RD12A Air-Cooled, 2-Cylinder, Honda GX630 Gasoline Engine**

A tandem vibratory roller with 35.4-inch (900 mm) drum width and an overall operating weight of 1.2 Tons includes dual drum drive and articulated steering for excellent maneuverability.

A front drum vibration and static rear drum offer a highly efficient and compact roller. This machine is ideally suited for commercial and residential compaction of asphalt and granular subbase material. Primary applications include parking lots, driveways, secondary roads, repair work and nature trails. Additionally, the RD12A is utilized for turf rolling in the landscape and golf industry segments.



**RD12A**

- RTxSC3 - The Smart Remote-Controlled Trench Roller**

The RT trench roller with the SC3 infrared-remote control offers proven compaction results with safer operation. The smart control uses an infrared signal with line-of-sight control. The machine stops moving, and vibrating should the line-of-sight be lost or if the operator comes within three feet (one meter) of the roller's receiving eyes with the control box. The articulated trench roller offers below the axle exciter in each drum to allow for the efficient transfer of compaction energy to the soil for superior compaction results. Available with the choice of Kohler or Kubota engine. The RTx models are available with Compatec, the compaction control system that indicates the relative compaction level of the soil.



Model	Oper. Weight	Drum Width (in)	HP	Cent. ForceFront Drum (lbf)	Frequency HZ	Engine / Motor type	Engine Manuf.
RTxSC3	3295	20.5	19.8	7700	41.7	3-cylinder diesel eng. W/lectric starter	Kohler KDW 1003



## WACKER NEUSON

### DUMPERS

- **Wheel Dumpers**

Articulated wheel dumpers are excellent for moving bulk materials. These versatile machines feature dumping from the front or either side of the skip and can maneuver across rough terrain as well as provide excellent traction on any surface.



DW90



DW60



DW50



DV90

- **Wheel Dumpers - Dual View**

**Safety redefined:** the dual view provides for a comfortable and quick change of the seat position through a 180° turn of the entire operating and seat console. The rotation can be performed conveniently from the driver's seat by simply unlocking the seat console and turning it around. In this way, the operator always has the best view - during transportation, loading and unloading. Say good-bye to time-consuming turning and maneuvering.







**WACKER  
NEUSON**

## LIGHT TOWERS

### • Compact Vertical Mast

The LTV4K, LTV6 and LTV8 light towers combine the features and performance of traditional light towers in a small footprint. They are ideally suited for illuminating general job sites, site prep, concrete pours, specialty events, parking lots, road work and bridge work. The adjustable vertical mast extends 23 feet and can rotate 360 degrees for optimum lighting flexibility.

- Compact design and foldable tongue allow transportation of up to 18 units on a 48-foot flatbed truck. Additionally, less space is taken up on site and in rental yards.
- Extended service intervals of 1,000 hours between oil changes lowers cost of ownership.
- Fast set-up times and a 45-gallon fuel tank extends lighting time
- Available with Kohler engines. All models feature a Mecc Alte generator end
- Metal halide or LED lamps provide lighting for any application

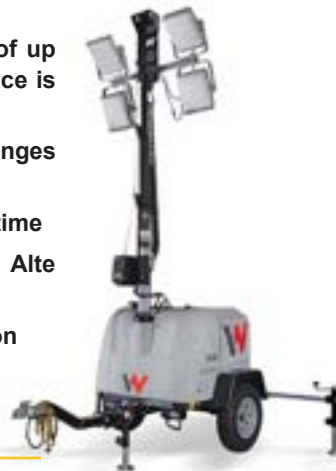

### • Wide Body

The LTW series of wide-body light towers combine superior job site lighting with various power options up to 20kW in a rugged, heavy duty steel frame. Wide track width, independent torsion axles and a heavy-duty tongue and hitch assembly ensure reliable off-road towing. The 30-foot adjustable tower rotates 360-degrees for optimum lighting flexibility. Equipped with large fuel tanks and simple engine controllers, these units are ideal for illuminating and powering remote and/or long run applications such as mining, security and disaster as well as general job sites.





**WACKER  
NEUSON**

## LIGHT BALLOONS

Wacker Neuson's light balloon features a compact and flexible design that quickly provides light where you need it. Thanks to its simple construction, set up of the **LBS 110M** is quick and easy. The elliptical shape of the lamp shade with the powerful 1000 W metal halide lamp offers maximum brightness without glare. That makes it ideal for road work, special events, concrete pours and general jobsite illumination. The height of the light point above ground is 16.4 ft (5 meters).

- **Simple single step mechanical balloon set up increases uptime and eliminates noisy fans to inflate balloon. Shape is also maintained in windy conditions.**
- **Single 1000-Watt metal halide lamp is securely fastened in socket to prevent damage when transporting. Bulbs can be replaced without the use of tools.**
- **Quick set up and easy storage of the entire light balloon system with limited parts and simple assembly.**
- **Sturdy, robust fiberglass tripod has adjustable legs and a level for greater flexibility and stability when placing the stand on uneven ground.**

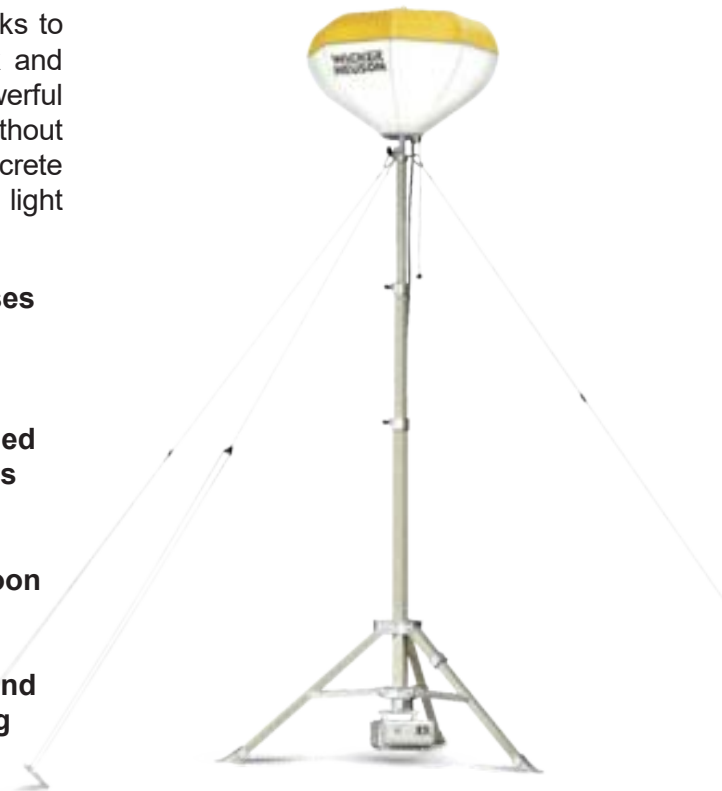

**LBS 110M**



**LBA 110M**

The **LBA 110M** is a fully functional light balloon without tripod (balloon, ballast and cord), designed for use with the customer's own equipment. The Wacker Neuson tripod is available as optional accessory - or you could buy the LBS 110M instead.

- **The powerful 1000 W metal halide lamp offers maximum brightness without glare. That makes it particularly suitable for road building sites.**
- **The diffused light from the balloon reduces shadows and contrast for bright, clear illumination.**
- **The actual balloon is constructed from a special foldable and durable material. The balloon does not need to be blown up. It is held open by metal supports.**
- **Quickly and easily attached to a scaffold or an asphalt paver, for instance.**



## PORTABLE GENERATORS

Designed for construction, rental and other demanding applications, these quiet, high-performance, portable generators deliver unmatched tool starting and voltage regulation in a rugged compact package.

Excellent for powering single or multiple tools on an entire job site or as emergency or standby power. Built with heavy-duty frames and premium components to provide long, trouble-free operation even in abusive environments. Ideal for powering high starting amperage tools such as compressors, grinders, fusion welders as well as all your Wacker Neuson electric power tools.

- A unique step-start generator technology with AVR (automatic voltage regulation) and separate excitation winding delivers best in class tool starting and voltage regulation.
- A super quiet muffler allows for versatile operation.
- Full wrap around frame with dual cross-member support, high impact polyethylene fuel tank and heavy-duty shock mounting combine to provide outstanding impact protection.
- Fully compliant with EPA evaporative emissions regulations



GP2500A



GPS9700A



GP6600A



## WACKER NEUSON

### MOBILE GENERATORS

If the power stops, everything stops. Wacker Neuson's mobile and container generators are engineered to reliably power your application while protecting your team, your equipment and your working environment. From events and disaster recovery to mining, roadwork and large industrial facilities, Wacker Neuson's extensive line of generators is performance driven. This includes use in extreme conditions. That's why we've become the preferred supplier of mobile generators with optional cold-weather packages. Our complete range delivers when it counts the most with a host of benefits for rental fleets and end users.

- **A user-friendly design** with simple operation.
- **The quietest in-class generators** for the most sound-sensitive applications.
- **An intuitive control panel** that features intuitive diagnostics capability
- **Custom factory-installed options**, including positive air shut-off for oil and gas, three-way fuel valve for auxiliary fuel tanks and cam locks.
- **Availability** is never a question with Wacker Neuson. We're ready to ship with a wide array of in-stock machines, as you need them.



G25



G70



G50



**WACKER  
NEUSON**

## PUMPS

- **Self Priming Trash Pumps**

Excellent pumping performance: Ideal for jobsite works. Our centrifugal pumps are perfect for construction sites that must be cleared of water quickly. They can handle solids of up to 25, 40 or 50 mm in size.



PT2A



PDT3

- **Diaphragm Pumps**

The PD diaphragm trash pumps are used for clear water as well as water containing debris or solids up to 1.75 inches in diameter. These pumps are ideal for mud, slurries and seepage application.

- **Electric Submersible Pumps**

Wacker Neuson's lightweight portable submersible pumps are used for dewatering clear water as well as water containing debris, solids up to ¼ in diameter.



PS2500



PG3A

- **Dewatering Pumps**

Are you looking for a compact dewatering pump with self-priming mechanism, ideal for smaller and short-term applications? These high-performance pumps from the PG series are designed for conveying water not containing large solids (Ø up to 6.5 mm). The dewatering pumps are equipped with a cast iron impeller, which is easy to adjust and at the same time has a long service life and is very easy to service.



## PORTABLE COMPRESSORS

For more than 50 years, Sullair has been on the leading edge of compressed air solutions. We were one of the first to execute rotary screw technology in our air compressors, and our machines are famous all over the world for their legendary durability. As the industry moves forward, Sullair will always be at the forefront with quality people, innovative solutions, and air compressors that are built to last.

Sullair's new line of portable compressors, ranging from 125 to 1900 cfm, is designed for compactness, maneuverability and accessibility for routine maintenance.

- **185 Series**

The workhorse of our elite mobile fleet. The Sullair 185 Series is fully optimized and ready to hit the road. The modern design is light and compact for easy maneuverability. It features multiple engine options to meet your needs; powered by your choice of a reliable Caterpillar or Kubota engine.

With 185 cfm at 100 psig, the 185 CAT features the same durability, simple serviceability and maneuverability customers have come to expect from Sullair.

The unit includes an improved 14-series air end assembled in the USA and a 27-gallon fuel tank providing up to 10 hours of use.

The 185 CAT meets the needs of a variety of applications, from sprinkler and irrigation line blowout to mining and construction.



- **260 & 200H Series**

### Tier 3 Compliant For Export Markets

Sullair has introduced its 260 Series portable lubricated rotary screw air compressors for Tier 3 markets. The 260 Series diesel compressors are powered by a turbo-charged Tier 3 emissions compliant Kubota V3307 engine with two pressure options.

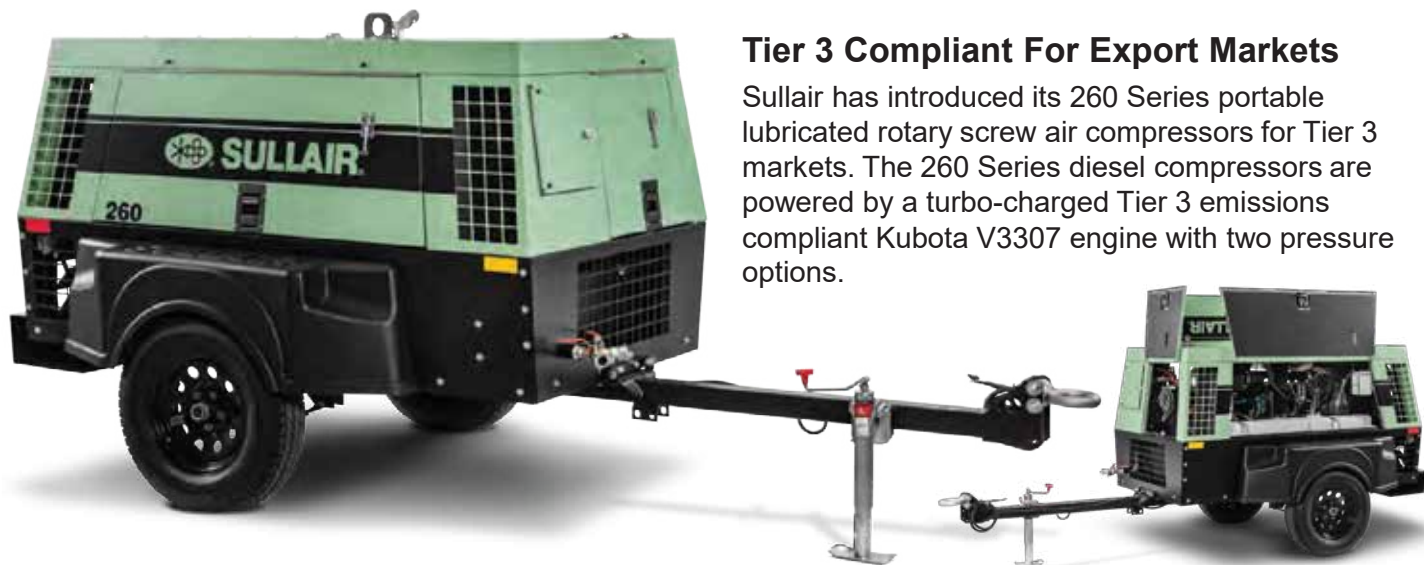

## PORTABLE COMPRESSORS

Sullivan-Palatek Inc., a leader in innovation and design, offers the industry's widest range of electric and portable rotary screw air compressors. From humble beginnings in 1984, Sullivan-Palatek has grown from providing engineering services to existing clients, to a privately owned company that manufactures the most rugged and reliable machinery available in the market.

Expertly engineered to fit the needs of private contractors and rental stores alike. Ranging from 100 to 1600 cfm, our portable air compressor units are the ideal compressed air solution for any job site. For a full list of models and capacities, please contact us.

- **185 CFM Series**

Built with the contractor in mind, the 185 cfm compressor series is a reliable ally on any job site. Providing 185 cfm at 100 psi, these machines are ideal for powering pneumatic tools and sandblasting. These 185 cfm Tier 4 Final compressors include two full length toolboxes, two large service doors, and galvanized inner fenders. For scratch and rust protection, the exterior of the machine is up-fitted with Galvanneal and powder coated sheet metal. Powered by a 49 hp diesel engine, this design has two stage air filter and large 29-gallon fuel tank for full shift duties.



**D185PDZ**

- **400 CFM Series**

The all-new Sullivan-Palatek D400PHHJD4 portable compressor is a versatile dual pressure/dual capacity unit, delivering 400 cfm at 215 psi or 450 cfm at 100 psi. At its core, the new model features a 173 hp John Deere Tier 4 final engine and a large 163 mm twin screw air end engineered and manufactured by Sullivan-Palatek. Other features include a full containment frame, remote drains, lockout aftercooler capability, large 80-gallon fuel tank, exterior lit fuel fill, fuel saving, and noise-reducing clutch fan, and an exterior that boasts a durable galvanneal enclosure with a powder coated finish for rust and corrosion resistance. The compressor is equipped with the SPEC full-service electronic controller, with digital readouts for everything from compressor temperature to aftercooler filter warnings. The controller also features the model's complete parts and service list for ease of maintenance.



**D400PHHJD4**



## CONSTRUCTION AIR TOOLS

Sullivan Palatek offers a complete contractor line of pneumatic tools from Paving Breakers, Rock Drills, Busters, Diggers, Chippers and Tampers. These tools are based on tired and true working designs. **Manufactured in the USA!**

### • Rock Drills

The Sullivan-Palatek line of drills are available in many weight sizes from 20-60 pounds and a large variety of chuck sizes. The SRD-75 is a heavy quarry drill suitable for drilling granite and available in two chuck sizes. The drill that can be used on high psi concrete it is a proven Toyo design and is available in two chuck sizes.



SDR-50



SCHO-2

### • Chipping Hammers

The full line of 15-pound class Chippers can come with open handles and thumb triggers, heavy-duty "D" style 4-bolt handles with Internal Triggers or Thumb Triggers. The open handle is forged and is machined from high alloy steel with a high shock, tool steel piston.



SCD-30

### • Clay Diggers

Available in two sizes: the 30 pound has the same rugged construction as the 30-pound breaker and has a "D" handle with internal trigger. The 20 pound has a machined cylinder with a cast "D" handle and thumb trigger.



SPB-60

### • Paving Breakers

The line of paving breakers include 30, 40, 60, and 90 pound "T" handle tools, all with industry standard chuck sizes. They are all built from a proven market design, 4 bolt back heads, heavy-duty side rod bolts and springs, forged alloy construction with removable chucks. Internal oilers on the 30, 60 and 90 pound breakers.



## • 190 - 240 cfm Towable Compressors

Atlas Copco's Small Towable Air Compressors are the next generation of towable compressed air solutions. A towable compressor is ideal for applications requiring portability. Suitable applications include job sites, mobile services, and small businesses.

Atlas Copco's Power Technique Business Area has a forward-thinking philosophy. For us, creating customer value is all about anticipating and exceeding your future needs – while never compromising our environmental principles. Looking ahead and staying ahead is the only way we can ensure we are your long term partner.

### Easy to use

An integrated toolbox inside the lockable canopy to store a 90lb hammer, an external lifting eye for easy lifting, user-friendly controller, canopy that opens 60° for easy access to all internal components and quick service. Designed to make your life easier.

### Long lasting quality

Depending on your application you might ask about robustness, durability, ruggedness or toughness – we have one simple word for all the above – The HardHat®. Protect your equipment and your investment.

### Increase your uptime

Service can be completed in less than 1 hour, thanks to easy access to all components and several features like spin-on filters. With the cold weather option, the compressor service interval of the XAS 188 increases from 1000 hours to 1500 hours or 2 years. In between the service intervals, Gives full peace of mind as the 110% fluid containment undercarriage avoids any spills.



## Total Control to Boost Your Efficiency

We believe a controller should put you in complete control, while being intuitive and most importantly easy to use and navigate. Easy to use means you don't waste any time controlling the compressor, while increasing your uptime.

- **400 - 440 cfm Mobile Air Compressors**

Atlas Copco's line of XATS 400 air compressors provide increased performance, efficiency, and reliability across a variety of applications. We offer three XAS models of air compressors including the XATS 400 CAT, XAS 440 JD, and XAS 400 JD, each built to provide exceptional durability and designed to withstand the toughest working conditions. These machines incorporate an intuitive PACE system (Pressure Adjusted thru Cognitive Electronics) making it possible to easily manage multiple pressure settings and flow settings according to your application needs. One machine has the power to cover multiple applications and replace the need for additional equipment — and with longer service intervals and an increased lifetime, these machines will lower ownership costs in the long run.

- **650 - 900 cfm Mobile Air Compressors**

Atlas Copco's line of XAVS 650 JD8 and XAS 900 JD8 air compressors are truly the most versatile on the market. With variable flow and pressure setting as standard features, our machines offer a wide range of applications — ultimately increasing your return on investment. Our two models offer a newly designed compact single axle platform with heavy-gauge, powder-coated galvanized steel. Their lightweight and compact design make these air compressors portable and easy to transport and maneuver on-site.



- **750 - 1800 cfm Low Pressure Compressors**

Low-pressure equipment is required for certain processes. Thus, Atlas Copco has developed a line of Large Low-Pressure Diesel Compressors to provide the appropriate amount of air. Depending on power needs, the XASs 950, XAS 1800 JD, or XAS 1800 CD provide reliable performance.



- **725 - 1550 cfm High Pressure Compressors**

Find the latest technology and versatility features in our line of large high pressure diesel air compressors for easy handling. The Atlas Copco V21, XRVS 1000, and XRVS 1550 allows for direct flow control features designed for volume and air flow control. Plus, an integrated controller is included with each model to allow for maximum ease of use.



- **110 cfm Mounted Air Compressor**

Consider Atlas Copco's XAS 110U KD vehicle mounted air compressor for portable efficiency. This oil-injected screw compressor is driven by a three-cylinder Kubota diesel engine and provides 110 cfm of FAD and 100 psi. Compared to most other air compressors, this model operates quietly, making it ideal for places where noise is a concern. This compressor is ideal for the following uses: small breakers for general construction, impact tools for onsite repairs, paint stripping applications, mobile tire repair applications, and small sandblast truck applications.

- **185 cfm Mounted Air Compressors**

The XAS 185 KDU T4F model by Atlas Copco is one of the industry's leading portable air compressors for various reasons. With a 49 horsepower Kubota engine and 185 cfm of free air delivered at 100 psi at 2.37 gal/hrs. it is easy to use, easy to service, and easy to transport. Other standard features include a low fuel shutdown system, central drains, a block heater, internal tool box, spin on compressor filter and a 12 volt negative ground electrical starting system. This compressor is ideal for the following uses: small breakers for general construction, impact tools for onsite repairs, paint stripping applications, mobile tire repair applications, and small sandblast truck applications.





## ASPHALT DISTRIBUTORS

E.D. Etnyre & Co. proudly manufactures a wide range of equipment that serves the asphalt roadbuilding industry, from asphalt distributors to chip spreaders and storage tanks to trailers. Since 1898, we've continually set the bar for performance and reliability and paved the way for customers' success. That success results from the way we build every unit to order and provide unparalleled support, from product selection to parts and service.

Etnyre continues to lead the industry with its legendary commitment to the market. Our products combine more than 100 years of experience with the latest technological advancements to provide customers with top performance and reliability. We take great pride in making excellent equipment that contributes to quality roads worldwide and benefits all the people who travel them.



In 1910 Etnyre launched the Road Oiler, which gave contractors a way to quickly and evenly spread oil, tar or asphalt across the roadways. The unit included a wheel driven (sprocket and chain) pump and a spray bar for proper product dispersion.

- **Centennial Series**

Set the bar on asphalt application accuracy and quality with our Black-Topper® Centennial asphalt distributors. The units' streamlined design minimizes maintenance while enhancing performance and productivity. Like all Etnyre equipment, we build every unit to order so you get the features and output you need to be successful.



Full Cab Control



Solid Pipe Circular System



Precise Control

Asphalt Distributors



HYDREMA 912G SERIES:

# Compact, highly mobile and off-road superior.

Articulated, compact dumptrucks. High power, low weight, durable and easy to operate. Providing efficiency and flexibility - every day, year after year.

In 1983 Hydrema launched our first compact dumptruck. Today these small, agile and robust dumptrucks work all over the globe. The 912G Series is the 9th generation.

#### Stable

The main reason for the success of the Hydrema 912 dumptruck is found in the articulated and oscillating pivot point.

The center pivot with hydraulic stabilisers keep the machine stable and safe by automatically transferring the weight to where it is needed. Furthermore, the 912GS / 912HM has a patented front axle suspension with auto levelling, which always gives a safe and comfortable drive.

The chassis design ensures that the front and rear wheels are running in the same

track, while the standard twin tyres give outstanding traction with minimum ground damage. The centrally placed articulation point increases the maneuverability with a small turning radius of just 20' and great positioning characteristics.

#### Easy to operate

Operating the 912G is easy and the driver becomes familiar with the machine functions and maneuverability in no time.

User-friendly controls, joystick operation, unrivalled visibility and a well-designed cabin ensures the best working conditions.

A well proven 6 speed ZF Soft-Shift transmission offers full auto or manual shift. This intelligent transmission will automatically shift 2 gears in the right conditions to smoothly increase acceleration regardless of the payload.

#### Strong and efficient

Whether the 912 is working on steep gradients or in poor ground conditions, it has the power to cope; state of the art 147 hp Cummins engine offers one of the best power-to-weight ratios on the market.

The high torque offers power at low revs. Together with an electrically controlled cooling fan which only operates when needed, the fuel economy and noise levels are improved. Great for both environmental and financial reasons.

Furthermore the engine has an upgraded, fully welded cooler, resulting in 10% increased cooling capacity.



- **Articulated Water Tanker**

A 10-ton, 2,500 gal. articulated water tanker with 4 spray heads and side winder on front that sprays 180° electronically operated from the cab. Two axels with unique articulated pivot joint gives unmatched stability.

### Chassis

Articulated chassis in heavy-duty robot-welded construction. Front axle suspension in pivot bearings and two spring cylinders. Pivot with pendulum bar and double hydraulic stabilizer with the option of locking the oscillation movement. Fuel tank and hydraulic tank are integrated into the front chassis. Oscillation: +/- 12°.

### Cab

Spacious ROPS / FORS approved cab with suspension. Mechanical air suspended seat and adjustable steering wheel.

### Fuel

37 gal. fuel tank integrated into the front chassis

### Dimensions:

Total Weight	41,120 Lb
Unladen Weight	20,120 Lb
Load Capacity	21,000 Lb
Track	6.3 Ft
Total Width	9.5 Ft
Ground Clearance	1.8 Ft
Total Height	9.5 Ft
Wheelbase	10.1 Ft
Overall Length	23 Ft
Turning Radius	20.8 Ft





## COMPACT PAVING PRODUCTS

Founded in 2000, Weiler is a cutting-edge manufacturer with 400,000 square feet of manufacturing space. The facility is equipped with machining tools, welding, powder and wet paint and assembly, allowing Weiler to better control quality and delivery for most of their machine components.

Located in Knoxville, Iowa, Weiler Inc. manufactures equipment for the asphalt paving market. Weiler equipment is based on proven designs that have a successful track record in the field. We work closely with contractors to ensure our products provide the features they require to complete projects in a timely and efficient manner.

- **Remixing Transfer Vehicles**

Weiler innovations have transformed the material transfer vehicle market since their introduction and continue to lead the industry with new features designed to increase productivity while reducing operating costs. Weiler MTVs build upon a proven platform to ensure optimal performance, reliability and cost of ownership.



E2850C



P385C

- **Commercial Pavers**

Weiler commercial class pavers deliver outstanding performance in a wide range of applications by providing highway-class productivity in a small, maneuverable package.

- **Road Wideners**

When it comes to placing the right amount of material at the correct grade and slope in one pass — whether on a shoulder or elsewhere — the best equipment for the job is a Weiler road widener, available in four convenient sizes capable of widening up to 14 feet.



W430A





## • Windrow Elevators

When there is a long road to pave, and you need to get the job done quickly, turn to the Weiler E650C and E550C windrow elevators. With a proven high-slat entry position and operator accessible chain speed and direction control, these rugged, feature-packed units help lead the way to high-production paving. The road to success starts with the right windrow elevator, and Weiler windrow elevators are designed to handle the toughest conditions while exceeding expectations.



E650C



C307A

## • Compactors

The C-Series split-drum compactors provide the compaction pressure you need, whether working on base materials or an asphalt mat. The split front drum enables the outer half of the drum to rotate faster than inner half resulting in quick work on corners and curves without mat tearing.

## • Force Feed Loader

Engineered to perform in a variety of applications year-round, the E1050 picks up soil, asphalt millings, snow, debris and other windrowed materials for high production material transfer.

30" variable speed and reversible conveyor belt with 600 fpm max speed discharges material directly behind or to either side of the conveyor with the optional 180° swivel conveyor.

The E1050 is powered by a Cat® C4.4 engine with 137 hp (102 kW). The feeder chain and conveyor are driven by high-torque, direct-drive motors eliminating high wear planetary gear boxes.



E1050



- **Soil Stabilizer**

Designed for varying applications, the S200 is available with either a soil or combination rotor. The 78" wide drum is powered by dual planetary drive motors with a max working depth of 14". Auto depth set point and auto load control provide accurate and efficient operation.

Engineered to perform in a variety of applications, the Weiler S200 Soil Stabilizer is available with two rotor options. The soil rotor provides stabilization that can greatly increase the integrity of the subgrade while the combination rotor provides in-place reclamation and a cost-effective way to recycle material without the expense of removing and replacing. The S200 performs with excellent mix quality and a dependable rotor drive system.



TT250

- **Tack Distributors**

Designed for the commercial paving contractor, the Weiler tack distributors provide high quality construction along with simple and efficient operation for commercial job site application. Available in 250 and 500 gallon configurations.

Weiler tack distributors are powered by a 5.5 hp (41 kW) Honda engine with clutched pump for easier starting and electric start option. The direct-drive pump is designed for asphalt with a capacity of 15 gpm.

- **Screeds**

Weiler front-mount and fixed screeds for Cat® highway-class pavers provide productivity and reliability in a durable package. Available in 8' and 10' wide models.





## • Motor Grader

The Model G65 has been the compact motor grader of choice for local, state and federal government bodies.

Municipalities absolutely love the power, reliability and ease of operation of the legendary machine built like the Big Boys! The versatile G65 is the perfect grader for road and shoulder maintenance, ditch cleanout, alley work, site preparation, recreation field development, and much, much more while saving government agencies dollars by lowering "owning & operating expenses".

### OPERATING WEIGHT

Front	4,700 lbs
Rear	12,200 lbs
Total	16,900 lbs

### ENGINE

<b>Cummins QSF3.8</b>	<b>Caterpillar C3.4</b>
4 Cycle, Turbo Diesel	4 Cycle, Turbo Diesel
4 Cylinder	4 Cylinder
Tier 4 Final	Tier 4 Final
120 hp	120 hp



G65 Turbo

## Features:

### EXCELLENT VERSATILITY

- Rough Cutting
- Mixing
- Spreading
- Fine Grading

### EASY TO OPERATE

- In-Line "Logic" Controls
- Automatic "Super Max-Trac" Differential
- Tight Turning Radius
- Full View Visibility
- Adjustable Control Console
- Power Brakes

### PLENTY OF POWER

- 120 hp CUMMINS or CAT Tier 4 Final Engine
- Six Speed Powershift Transmission
- High-Capacity Torque Converter
- Torque Proportioning Rear Axle

### MANY "OPTIONS" AS STANDARD EQUIPMENT

- Circle Side Shift
- Hand and Foot Accelerator / Decelerator
- High Floatation Tires
- Five Point Tie-Down System
- Turn Signals, Stop and Taillights, Work Lights
- "Rollaway" Profile Moldboard
- Deluxe "Air Ride" Adjustable Seat

### OUTSTANDING VALUE

- Low Maintenance Costs
- Easy to Transport
- G65 Retains Exceptional Resale Value



## XTREME TELEHANDLERS

Xtreme Manufacturing offers the largest and most comprehensive line of heavy-duty and high capacity telehandlers in North America. Designed to deliver a long-working life with low total ownership costs, all Xtreme products are built around a core focus on safety, reliability and serviceability, and are backed by an industry-leading 10 year – 5 year – 2 year warranty. Innovative features such as 360 degree operator visibility from the cab, an integrated machine-rated boom lift point for handling suspended loads, and intuitive controls that permit one hand on the steering wheel at all times, deliver the Xtreme Difference to our customers.

Today, Xtreme Manufacturing offers the largest product line of rough terrain telescopic handlers (telehandlers) in North America. Spanning 15 models, with lifting capacities ranging from 5,900 lbs. (2,676kg) to 70,000 lbs. (31,751kg), and maximum lift heights of up to 70 ft. (21.3m), Xtreme Manufacturing has a telehandler suited to virtually any application and environment.



XR1055



XR1147



XR1255

Model	Max Lift Capacity	Max Lift Hight	Max Forward Reach
XR1055	10,000	55	39.00
XR1147	11,000	47	31.60
XR1245	12,000	45	30.40
XR1255	12,000	55	38.00
XR1534	15,000	34	17.00
XR1570	15,000	70	53.10
XR2034	20,000	34	16.7
XR2042	20,000	42	24.10



XR7038

### • Ultra Xtreme Capacity Roller Boom

The award-winning Xtreme Manufacturing XR7038 is a large capacity forklift that lifts an incredible 70,000 lbs. for heavy duty applications. It also claims the title as the largest capacity rough terrain telehandler across the United States, Canada and Mexico.

An Xtreme Manufacturing design, the XR7038 delivers 360° visibility and easy maintenance access with durable all-steel construction. Its dynamic design lifts and loads to a maximum height of 38 ft. 2 in. with 22 ft. forward reach.

Model	Max Lift Capacity	Max Lift Hight	Max Forward Reach
XR7038	70,000	38	22.00

## SWEPPERS

For over 40 years, at construction sites throughout the nation, chances are a LayMor sweeper was on the job. We help contractors clean up their job sites and equipment store owners clean up when it comes to sweeper rental revenue. We've always built a quality construction sweeper, but when you walk through our timeline, you'll also see something else: innovation that's been at the forefront of the industry.

- **SweepMaster 300**

Two reasons why the SweepMaster 300 is so popular is it's easy to tow and very operator friendly. Another reason is it can clean a variety of surfaces, it's used as a gravel sweeper, construction street sweeper, and is also great for oily surfaces. It also enjoys a superb reputation as a parking lot sweeper rental.

The SweepMaster 300 hitches up to the back of your truck in seconds with our advanced hitch/towing package, coming standard, and there's no need to raise the front wheel off the ground while towing.

New features include a powerful Kubota 24.8 HP engine, a lower center of gravity, hydraulic manifold block, and a foot brake. Options include variable broom speed, special paint colors, strobe light, work lights, and emergency and stop/turn taillights.



- **SweepMaster 450-ST**

For the bigger jobs like a highway or larger construction project, the SweepMaster 450-ST is the construction street sweeper your customers will crave. It takes the best attributes of the SweepMaster 300 and puts them in a bigger construction sweeper. The cab features more height for increased driver comfort, increased operator visibility, a forward-slant windshield to reduce dirt and dust accumulation, a tighter turning radius, multiple auxiliary power outlets, large cup holders, and a lot more, all standard.

Its long list of options include a block heater and even an AM/FM stereo. The SweepMaster 450-ST is the rental sweeper that's up for any challenge.





## • SCM 210 Bucket Replacement Sweeper

The Bucket Replacement Sweeper can be used on tractors that run from 30 to 150 Horsepower. This sweeper can be mounted on small and large front end loaders and includes a brush float system (patent pending). This sweeper comes complete with the manual Quick-Change Brush System that allows for the brush to be changed onsite in (approx.) 5 minutes with the removal of one safety bolt. Regardless of its application, such as use on a construction site, asphalt plant, runway, raceway, warehouse, parking lot or beyond this sweeper is built to last and is sure to be an asset on any job site.



## • SCM 200 Skid Steer Mount Sweeper

The Skid Steer Mount Sweeper is designed for bucket replacement applications and is equipped with a manual Quick-Change Brush System, allowing the brush to be changed onsite in (approx.) 5 minutes. Additionally, this sweeper has a brush float system that is currently patent-pending. This model is used in a variety of ways, on construction sites, asphalt plants, raceways, warehouses, runways and more, the Skid Steer Mount Sweeper is sure to be an asset on any job site.



## • Replacement Brooms

Our Tube Broom requires zero wafers and is changed via the Quick-Change System, drastically improving efficiency on any job site. This brush comes in two filament options: Poly and Poly Wire Combo and is offered in a variety of lengths from 77.5 inches to 96 inches. Similarly, our Pan/Hopper Brooms are available in three lengths: 60 inches, 72 inches and 84 inches. Additionally, we provide wafers with the following filament options: Wire Convolved or Poly Convolved, are compatible with a variety of sweeper models.





## • SCM 100 – Tractor Front Mount Sweeper

The Challenger 1 SCM 100 Tractor Front Mount Sweeper has been used in the construction industry for many years due to its robust design. Regardless of its application, such as use on a construction site, asphalt plant, runway, raceway, warehouse, parking lot or beyond this sweeper is built to last. Its hydraulic Quick-Change Brush System allows for the brush to be changed on site in approx. 2 minutes. Engineered with innovative prowess, this sweeper requires minimal replacement parts and often outlasts the very tractor it is mounted on.

### SCM 100 Details

- Heavy Duty Construction for Long Life and Less Maintenance
- Horsepower Requirements: 40 to 60 HP
- Brush Drive: Hydraulic
- Sweeping Angle: 40 Degrees Right -0- 40 Degrees Left (HYD)
- Weight: Approximately 1400 lbs
- Oil Capacity: 24 Gallons (varies slightly per tank design)
- Brush Frame Lift: Approximately 36"
- Brush Length: 77.5" (100% Poly or Poly Wire Combo)
- 35" Diameter Tube Style Brush
- Grease Fittings and Replaceable Bushings/Bearings
- Self Cooling Oil Reservoir
- PTO Driven Pump – 3000 psi rated PTO Pump / Gear Box
- Dirt Deflector

### SCM 100 Options

- Water Mist System
- Brush Hood Extension
- 89.5" Brush Length
- Custom Tires and Wheels
- Customized Engine Air Filtration
- Rear Mount Scrape Blade
- Customized A/C Inlet Filter
- Variable speed brush rpm
- Tractor can be outfitted to meet your specifications

144 GALLON  
FENDER TANK  
WATER SUPPRESSION  
SYSTEM

\*Optional Equipment

### KELLY TRACTOR BROOM PACKAGE OPTIONS

- » Buzzanator H/D alternator
- » Back up camera
- » Fender tank kit
- » Four wheel drive
- » Flex Blade Asphalt Box Blade — with or without water
- » R3 turf type tires
- » Side-shift package



## KELLY TRACTOR EXCLUSIVE



- **SUPER BROOM – SCM 400**

The SUPER BROOM SCM 400 Self Propelled Sweeper is designed to be the most innovative self-propelled sweeper on the market. The features were designed with years of industry experience. From the visibility in the cab to the accessibility and ease of engine maintenance, the SCM 400 self propelled sweeper is an all-around valuable asset to road construction projects, including milling operations, road resurfacing, airport runways, and a variety of other construction site needs.

## SWEEPER ARM FEATURES



### **Spray Bar**

Spray water while sweeping in front of the machine to reduce or eliminate dust. Bar folds back and securely latches without the use of tools when not in use and for travel and safety.



### **Side Shift**

Allows for the broom head to shift 11" left to right from center. This option helps to prevent pre-matured tire failure. Allowing the operator to run the machine away from curbs, retainer walls, milling cuts etc.



### **Quick Change Arm**

Replacement brush can be changed out in less than 2 minutes with no tools required, while on the job site.



### **Front Dirt Deflector**

The front dirt deflector reduces dust and debris while sweeping.



### **Rear Dirt Deflector**

The rear dirt deflector helps protect the machine from dust and debris while sweeping in reverse.



### **Grease Fitting**

Single Point Greasing System.







SUPERTRAK® is a Florida Corporation formed in 1986. We are an original equipment manufacturer (OEM) company utilizing Cat® components. We design and manufacture a complete line of vegetation management and land clearing units. SK170 MX, SK170 RTL and SK350-PP (**Power Pack**)

Over the past 35 years, SUPERTRAK® has been requested to build custom machinery by numerous customers. This effort has involved complete design responsibility as well as build to print. The company has built heavy-duty trenchers, mechanical citrus harvesting equipment, custom utility trucks, cable retrieval equipment, monorail work tractors, and vegetation management equipment..



The **SK170 MX** is a Custom single Engine High Horsepower Excavator Compact designed to offer Maximum Horsepower to the Mulching Attachment. It is Built with Cat Components for excellent product support from your local Caterpillar Dealer or SUPERTRAK® Directly.



The Supertrak **SK170 RTL** is a compact machine built for mobility and power to suit numerous applications such as land clearing, vegetation management, right-of-way maintenance, rock grinding and snow removal. All major components are CAT® for excellent product support from your local Caterpillar dealer or SUPERTRAK® directly.

Model	Engine	HP	Fuel Tank (Gal)	Base Unit
SK170 MX	Cat® C4.4	170	66	Cat 313GC
SK170 RTL	Cummins 4.5 T4 -Stg. 5	170	50	Cat 908M

## • SK350-PP POWER PACK

The **SK350-PP** (Power Pack) boosts hydraulic power for applications such as forestry mulching, land clearing and vegetation management. It can be mounted to a variety of machines, including excavators where it can replace the counterweight. All major components are CAT® for excellent product support from your local Caterpillar dealer or SUPERTRAK® directly.



Model	Engine	HP	Fuel Tank (Gal)	Base Unit
SK350-PP	C9.3b Tier IV	350	150	Cat 320E

## TELESCOPIC HANDLERS

Our understanding of the market, our ability to get ahead of the game and our undeniably Italian skills are written into our very DNA and have been the key to Magni Telescopic Handlers' rapid success.

Production of Magni's telescopic handlers started in January 2013. Thus began the development of the widest range of rotating telescopic handlers on the market, consisting of 16 models. There are also eight fixed, heavy-duty models and a new range of eleven fixed telehandlers. As a testimony to Magni's success, in the last two years Magni has created not only the two tallest rotating telescopic handler models in the world but also the model with the highest payload.

To offer our clients the best technical and commercial service around, we have created a network of over 300 dealers, a number that is constantly increasing.

- **Rotary Telescopic Handlers**

The rotary telehandlers are extremely versatile and flexible machines. They are used for many applications being able to equip various accessories such as forks, winches and platforms and being equipped with 360 ° rotation. All Magni lifts work in complete safety, thanks to the patented load control system that detects the risks of overload during use and inhibits further aggravating movements. Reliable and multi-function are real 3-in-1 machines.



6.25

Model	Max. Capacity	Max. Height	Model	Max. Capacity	Max. Height
4.18	8,800 lbs	58'	6.30	13,200 lbs	97' 9"
5.18	11,000 lbs	57' 2"	6.35	13,200 lbs	114' 6"
5.21	11,000 lbs	67' 3"	6.39	13,200 lbs	127' 7"
5.23	11,000 lbs	74'	6.46	13,200 lbs	149' 7"
5.25	11,000 lbs	82'	6.51	13,200 lbs	167'
6.21	13,200 lbs	68' 3"	7.26	15,500 lbs	84' 3"
6.23	13,200 lbs	76' 4"	8.25	17,500 lbs	81' 8"
6.25	13,200 lbs	82'	13.26	28,600 lbs	85' 11"



6.35



6.39



6.46

- **Heavy-Duty Telehandlers**

From 10 to 45 tons of capacity, Magni heavy-duty telehandlers are ideal for the heaviest jobs in the industrial, port and mining fields, guaranteeing rapid maneuvering and high stability. Thanks to their design designed for the heaviest jobs they are the ideal partners for those who need performance and reliability even in extreme conditions. The undisputed champions for any tough job.

Model	Max. Capacity	Max. Height
HTH 10.10	22,000 lbs	31.2'
HTH 16.10	35,280 lbs	31.1'
HTH 20.10	44,100 lbs	32'
HTH 24.11	53,200 lbs	34.6'
HTH 27.11	59,500 lbs	35.8'
HTH 30.12	66,140 lbs	37' 5"
HTH 35.12	77,000 lbs	37' 5"
HTH 50.14	110,000 lbs	46'



HTH 20.10

HTH 24.11

HTH 27.11



35.12

## • Fixed Telehandlers

Safe, strong and reliable our fixed telehandler range combines craftsmanship with innovation and technology to aim for high-end performance in each application, choose the right Magni for your needs. The TH range is flexible and adapts to your needs: from industry to construction and mining sectors, Magni models are perfect for every application.



**SIDE-SHIFT**

Model	Max. Capacity	Max. Height	Model	Max. Capacity	Max. Height
5.8	11,000 lbs	24' 11"	5,5.15 P	12,100 lbs	48' 7"
5.8 P	11,000 lbs	24' 11"	5,5.19	12,100 lbs	61' 8"
5.8 MINING	11,000 lbs	24' 11"	5,5.19 P	12,100 lbs	61' 8"
6.10	13,200 lbs	32' 2"	5,5.24	12,100 lbs	78' 5"
6.10 P	13,200 lbs	32' 2"	6.20	13,200 lbs	63'
5,5.15	12,100 lbs	48' 7"			



5,5.24



6.10



6.10 P



5,5.15



## CRANES

Kelly Tractor Co. offers Florida's premier solution for your lifting needs. As an Authorized Dealer for Link-Belt cranes, we provide the full compliment of construction cranes for both sales and rental.

Our dedicated sales and support staff consists of the most experienced professionals in the industry. Our objective is to meet and exceed all your crane needs with the highest quality products backed by the best parts and service team in the business. Whether you are in the market to purchase or simply rent, Kelly Tractor Co. is the best choice.

South Florida - Julio Rivas - Phone: (305) 613-1571 - Se Habla Español

North Florida - Hugo Verez - Phone: (407) 399-1248 - Se Habla Español

Parts (561) 683-2015

www.kellytractor.com/cranes

- **All Terrain Cranes**

Link-Belt is committed to the design, manufacture and service of quality products that satisfy the needs of its customers worldwide. Link-Belt operates on the principles of continuous quality improvement, ISO 9001, and established values that support the vision of quality.



ATC-3275



ATC-3210



175/AT



## • Telescopic Truck Cranes

Link-Belt dealers are some of the finest on the globe. We are ready to take on your challenges and furnish the know-how that keeps your cranes ready to work. Link-Belt has dedicated full time regional service technicians and factory technical advisors available to maximize up-time for your cranes. In addition, our dedicated 72,000 sq. ft. Parts Distribution Center is an integral part of the Link-Belt product support commitment.



HTC-8690 LB

## • 65TH Telescopic Truck



A 65-ton (55-mt) capacity truck crane to replace its HTC-8660 Series II. The 65|HT comes with a new four-section 36.5 ft. – 115 ft. (11.2 – 35 m) full-power boom that reaches a maximum tip height of 125 ft. (38.1 m). The 65|HT boasts an all-new formed boom riding Link-Belt's proven Teflon- impregnated wear pads, which means there's no need to grease the boom – reducing the time and cost of upkeep.

## • 120TH Telescopic Truck

- Improved and unmatched efficiency in transportability for all geographic markets
- Industry first suspension and axle design: independent air-ride suspension & air disc brakes
- 10 percent higher gross axle rating (51,200 lbs. on front tandem) than any other truck crane in the market
- Link-Belt SmartFly: different configurations to address any jobsite need
- NEW for the 120|HT: 3 piece 9.5'-35'-58' fly with integrated heavy lift section
- All new carrier cab: NEW wider carrier cab, 9 in wider than current truck crane cab
- TPMS – Wireless Tire Pressure and Temperature Monitoring
- Smart Stack counterweight monitoring system



120HT

## • Rough Terrain

The industry's most innovative solution to big rough terrain cranes, maneuverability, and transportability!

The smaller tires give them an overall height that is ideal for hauling, along with their individual six-wheel hydrostatic drive. There is no crane in the world, any size, that can come close to the job site maneuverability and performance of Link-Belt's large RTC Series II machines.



85RT



RTC-8090

## • Telescopic Crawler

Your crane investment is always protected.

The ultimate value of a machine begins with state of the art design and quality manufacturing, but it is the excellent Link-Belt distributor product support that determines its long-term value.



TCC-550



TCC-2500

**Link-Belt**  
C R A N E S

Rough Terrain & Telescopic Crawler Cranes



- **Lattice Crawler Cranes**

It takes more than just a crane. It takes answers, even at midnight, wherever you are. Link-Belt Preferred delivers around-the-clock availability. Find 3D eManuals and specifications online for almost every Link-Belt crane. Calculate ground bearing pressure or view part diagrams – it's all there. Need a complete lift plan? 3DLiftPlan.com is quick and easy and Link-Belt provides free access for all 3D cranes to be used

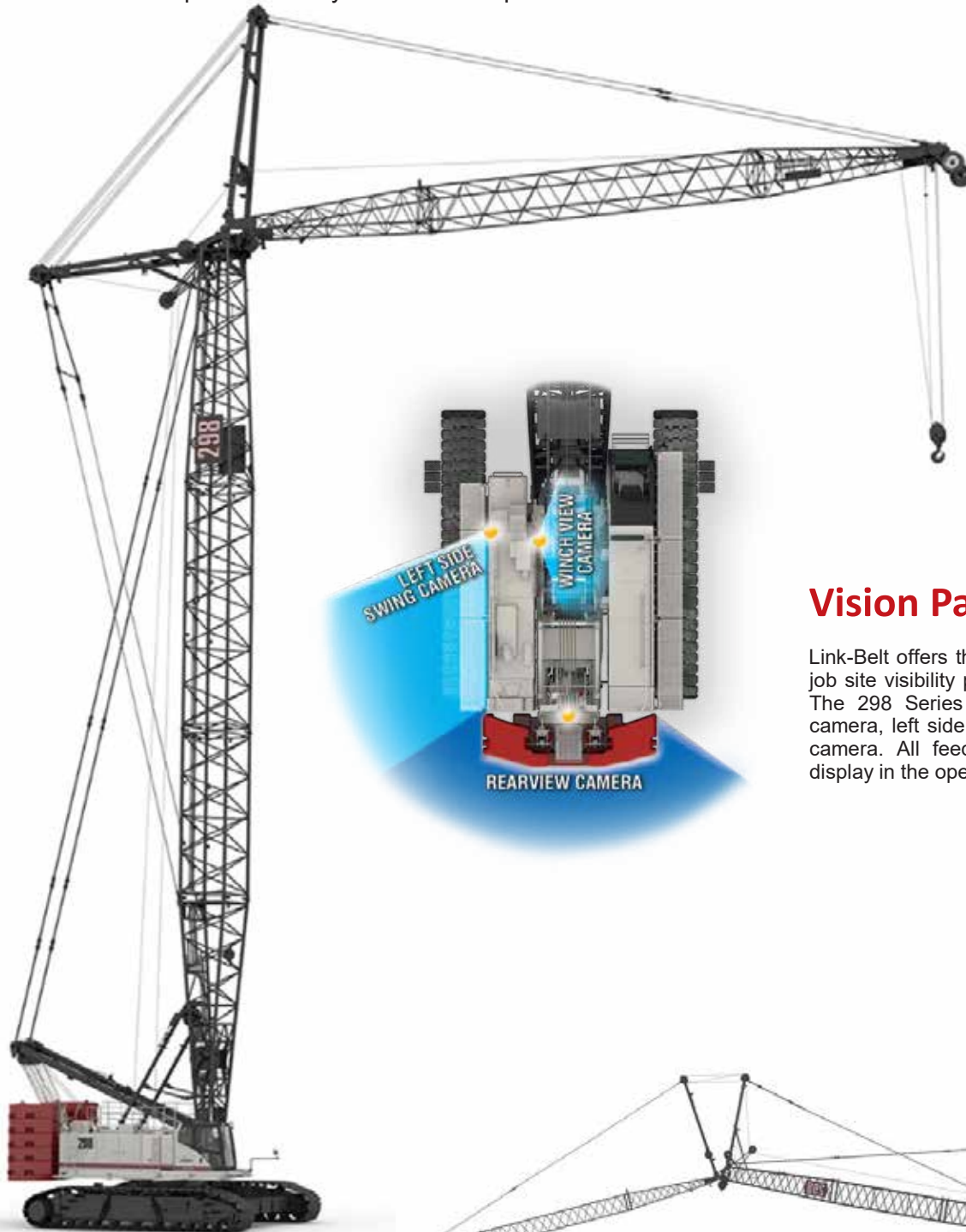

298 -S2

### Vision Package

Link-Belt offers the most comprehensive job site visibility package on the market. The 298 Series 2 features, rear view camera, left side swing, and winch view camera. All feeding to a full color 7" display in the operator's cab.





## DRILL RIGS

THE PERFECT BLEND OF TECHNOLOGY, PERFORMANCE AND PRODUCT SUPPORT

Known the world over, IMT hydraulic rigs are regarded as the most reliable, productive, stable and operator friendly within the drilling industry. Kelly Tractor Co. maintains the largest rental fleet in the Western Hemisphere by supporting foundation contractors with rigs designed to get the job done in a variety of soil and rock conditions.

IMT drill rigs meet all current emissions requirements and standard. Our dedicated product support team ensures that our rigs are ready when you are.

Additionally, Kelly Tractor Co. operates a 30,000 sq. ft. state of the art manufacturing facility in Central Florida which is capable of design and fabrication of replacement kelly bar parts as well as repairs and rebuilds. Our fabrication and welding procedures along with proper metals analysis ensure your project is done right.



A125



A300

[www.kellytractor.com/foundation-group](http://www.kellytractor.com/foundation-group)

Sales and Rental (888) 955-3559  
 Parts (561) 683-2015  
 Service (863) 354-9036

Model	HP	Operating Weight w/Kelly Bar LBS
A125	173 @ 1900 RPM	Standard 77,170 / LCA 74,520
A150	227 @ 1900 RPM	Standard 103,070 / LCA 94,910
A216	350 @ 1800 RPM	Standard 125,670 / LCA 116,850
A250	375 @ 1900 RPM	Standard 152,120 / LCA 139,340
A270	415 @ 1800 RPM	Standard 156,750 / LCA 141,100
A300	440 @ 1800 RPM	Standard 207,240 / LCA 194,010



A216

## CAT® LIFT TRUCKS

With load capacities ranging from 2,500 to 36,000 lbs., Cat Lift Trucks product offerings consist of electric counterbalanced cushion and pneumatic tire lift trucks as well as internal combustion cushion and pneumatic tire forklifts. With a dedicated focus on quality, reliability and customer service, Cat Lift Trucks offers innovative material handling solutions.

- **Electric 3-Wheel Pneumatic Tire**

Combining the latest in operator ergonomics and advanced AC control, the Cat® series of three-wheel electric lift trucks provide maximum power and performance in a variety of applications.

Model	Capacity (lbs)	Voltage (V)	L x W x H	Weight (lbs)
2ET2500	2,500	48	69.9 x 41.7 x 80.4	5,947
2ET3000	3,000	48	78.6 x 41.7 x 80.4	6,627
2ET3500	3,500	48	78.6 x 44.1 x 80.4	6,957
2ET4000	4,000	48	78.6 x 44.1 x 80.4	7,343



2ETC3000



EC25N

- **Electric Cushion Tire**

The Cat® electric cushion tire lift truck series gives your operators the tools they need to drive your business forward. Work longer with up to two shifts on one battery charge without sacrificing performance, thanks to Cat Lift Trucks 3-phase AC technology and regenerative braking.

Model	Capacity (lbs)	Voltage (V)	L x W x H	Weight (lbs)
EC15N	3,000	36 / 48	78 x 37 x 86	6,270
EC18N	3,500	36 / 48	78 x 37 x 86	6,290
EC23N	4,500	36 / 48	124.1 x 82 x 88	8,750
EC25N	5,000	36 / 48	124.1 x 82 x 88	9,100
EC30N	6,000	36 / 48	130.2 x 88 x 88	9,300

- **Electric Pneumatic Tire**

The Cat® series of electric pneumatic tire lift trucks offers maximum performance for a wide range of applications. Designed to thrive in tough environments, this series features all the benefits of an electric forklift combined with the strength and power you'd expect from internal combustion engines.

Model	Capacity (lbs)	Voltage (V)	L x W x H	Weight (lbs)
EP3000	3,000	36 / 48	82.6 x 44.1 x 80.4	6,503
EP3500	3,500	36 / 48	82.6 x 44.1 x 80.4	6,812
EP4000	4,000	36 / 48	82.6 x 44.1 x 80.4	7,175
2EP5000	5,000	80	96.1 x 47.2 x 88.2	10,311
2EP6000	6,000	80	96.3 x 47.2 x 88.2	11,303



2EP5000

## • Small Cushion Tire Lift Trucks

The Cat® 3,000-6,500 lb. LP gas cushion tire series offers what businesses demand: fuel economy, reliable performance and greater operator control. Built for dependability, these forklifts can operate in a wide range of indoor applications to move goods, stage pallets or transfer loads.



2C3000 – 2C6000

Model	Capacity (lbs)	Turning Radius	Fuel	L x W x H	Weight (lbs)
2C3000	3,000	70.0	LP Gas	82 x 38 x 81	6,065
2C3500	3,500	71.0	LP Gas	83 x 38 x 81	6,450
2C4000	4,000	77.5	LP Gas	90.5 x 42 x 81.5	7,360
2C5000	5,000	79.5	LP Gas	92.5 x 42 x 81.5	8,155
2C6000	6,000	82.5	LP Gas	96.5 x 42.4 x 81.5	9,480



## • Mid-Size Cushion Tire Lift Trucks

Powered by a rugged PSI 4X 4.3-liter V6 EPA compliant engine, the Cat® GC35K - GC70K series of cushion tire lift trucks are built to perform multiple jobs in a variety of applications. From off-loading trailers to moving goods in and out of racking, these highly-configurable and flexible lift trucks offer the robust performance and reliability your business demands, while featuring practical options and attachments to enhance this truck's agility.



GC70K

GC55K

Model	Capacity (lbs)	Turning Radius	Fuel	L x W x H	Weight (lbs)
GC35K	7,000	88.0	LP Gas	98.8 x 46.5 x 86.8	11,550
GC40K	8,000	90.0	LP Gas	100.4 x 46.5 x 86.8	12,280
GC40KSTR	8,000	82.3	LP Gas	94.9 x 46.5 x 86.8	12,470
GC55K	12,000	100.4	LP Gas	114.6 x 52 x 86.8	15,850
GC60K	13,500	101.2	LP Gas	116.1 x 56.7 x 88.8	19,310
GC70K	15,500	101.2	LP Gas	116.1 x 56.7 x 88.8	20,900



GC45K-STR

(STR) Short Turning Radius

## • Small Pneumatic Tire Lift Trucks

Give your business a lift in productivity – by 10% with the Cat® 3,000 - 7,000 lb. IC pneumatic tire lift truck series. Proven to move 10,400 more loads per year than the leading competition\*, this series pushes through the hardest workdays to help you move more – all day, every day.



DP15N

GP25N

DP30N

Gas / LPG - Models	Capacity (lbs)	Turning Radius (in)	L x W x H	Weight (lbs)
GP15N	3,000	76.8	89.0 x 41.9 x 84.5	5,650
GP18N	3,500	78.0	90.4 x 41.9 x 84.5	6,070
GP20N	4,000	86.6	98.0 x 45.3 x 84.5	7,370
GP25N	5,000	87.8	100 x 45.3 x 84.5	7,990
GP30N	6,000	93.7	107 x 50.2 x 85.5	9,400
GP35N	7,000	96.1	110 x 50.8 x 90.5	10,340
Diesel - Models	Capacity (lbs)	Turning Radius (in)	L x W x H	Weight (lbs)
DP20N	4,000	86.6	98.0 x 45.3 x 84.5	7,540
DP25N	5,000	87.8	100 x 45.3 x 84.5	8,210
DP30N	6,000	93.7	107 x 50.2 x 85.5	9,640
DP35N	7,000	96.1	110 x 50.8 x 90.5	10,590



GP30N

## • Mid-Size Pneumatic Tire Lift Trucks

Designed to operate in tough environments, the Cat® GP40N-GP55N/DP40N-DP55N series is equipped with a powerful engine and durable mast – delivering the rugged performance you need to get the job done.



GP40N

Gas / LPG - Models	Capacity (lbs)	Turning Radius (in)	L x W x H	Weight (lbs)
GP40N	8,000	102.0	118 x 55.7 x 91.3	12,920
GP45N	9,000	107.0	123 x 57.5 x 91.3	13,820
GP50N	11,000	114.0	130 X 57.5 X 94.5	15,960
GP55N	12,000	116.0	132 X 57.5 X 94.5	16,690
Diesel - Models	Capacity (lbs)	Turning Radius (in)	L x W x H	Weight (lbs)
DP40N	8,000	102.0	118 x 55.7 x 91.3	13,050
DP45N	9,000	107.0	123 x 57.5 x 91.3	13,960
DP50N	11,000	114.0	130 X 57.5 X 94.5	16,090
DP55N	12,000	116.0	132 X 57.5 X 94.5	16,840

## • Large Pneumatic Tire Lift Trucks

The Cat® DP70, DP100N2-DP160N2 pneumatic tire lift truck series provides optimum power and reliability to tackle some of the toughest material handling applications. Equipped with a high-performance Perkins™ engine, this series offers increased fuel efficiency, reduced emissions and a lower overall operating cost, and proven reliability and durability, combined with the strength and stability you need to get the job done.

Diesel - Models	Capacity (lbs)	Turning Radius (in)	L x W x H	Weight (lbs)
DP70N1	15,500	130.0	141 x 85.4 x 101.5	20,770
DP100N2	22,000	164.0	177 x 99 x 121.5	32,280
DP120N2	26,500	164.0	178 x 99 x 121.5	34,580
DP135N2	30,000	164.0	179 x 103 x 131.5	38,930
DP150N2	33,000	179.0	191 x 103 x 131.5	40,230
DP160N2	36,000	190.0	199 x 104 x 139	42,170



DP150N2

## • Hand Pallet Jacks

Cat® hand pallet trucks are made tough, while maintaining operator comfort throughout the shift. High-quality construction and a cost-effective design combine for greater uptime and a lower overall cost of ownership.

### FEATURES

- Reinforced Ergonomic Handle
- Entry/Exit Roller System
- 13 Grease Zerks at the Pivot Points
- Adjustable Push Rods

### WARRANTY

- 1 year on pump—full pump replacement
- 6 months on all other parts



Models	Capacity (lbs)	Fork Width	Fork Length	Steer Wheels	Load Wheels
A500002036	5,500	20"	36"	Polyurethane	Polyurethane
A500002043	5,500	20"	43"	Polyurethane	Polyurethane
A500002048	5,500	20"	48"	Polyurethane	Polyurethane
A500002736	5,500	27"	36"	Polyurethane	Polyurethane
A500002748	5,500	27"	48"	Polyurethane	Polyurethane



## • Galvanized Hand Pallet Jacks

Cat® hand pallet trucks are made tough, while maintaining operator comfort throughout the shift. High-quality construction and a cost-effective design combine for greater uptime and a lower overall cost of ownership. Our galvanized hand pallet truck is ideal for freezer and refrigerated applications. The galvanized coating performs well under extreme cold and protects the steel from corrosion.

Models	Capacity (lbs)	Fork Width	Fork Length	Features	Steer Wheels	Load Wheels
A5G0002748	5,500	27"	48"	Galvanized	Nylon	Nylon
A5G0002749	5,500	27"	48"	Galvanized	Nylon	Tandem, Nylon

## • Scale Pallet Jacks

Our scale pallet truck helps you save time with a built-in solid-state large LED display for weighing products in transit instead of transferring to a platform scale. High-quality construction and a cost-effective design combine for greater uptime and maximum productivity.

### FEATURES

- Mobile pallet truck with scale included
- Power supply with rechargeable battery or with 88-264V AC input
- Keypad and automatic tare functions
- Solid-state large LED display (measures 1.2")
- Displays pounds and kilograms
- Fast and accurate weighing

Models	Capacity (lbs)	Fork Width	Fork Length	Steer Wheels	Load Wheels
A500002745	4,409	27"	45"	Polyurethane	Polyurethane





## MITSUBISHI FORKLIFT TRUCKS

Customers around the world have relied on Mitsubishi forklift trucks to keep their businesses moving for more than 30 years. Building upon the diverse experience and innovation of the Mitsubishi brand – a worldwide name in industries such as aerospace, manufacturing and electronics – the Mitsubishi forklift trucks product line is known for providing reliable forklifts at an exceptional value.

### • 3-Wheel Electric Forklift

The 3 - Wheel electric counterbalance forklift series, featuring a heavy-duty AC drive and hydraulic motors, is compact, ergonomic and powerful.

Model	Capacity (lbs)	Voltage (V)	L x W x H	Weight (lbs)
FB16PNT	3,000	36/48	72.8 x 42.9 x 80.7	6,826
FB18PNT	3,500	36/48	77.1 x 42.9 x 80.7	6,085
FB20PNT	4,000	36/48	78.1 x 42.9 x 80.7	6,327



FB16PNT

Electric Forklift



FB18PNT

### • Small Electric Forklift

The electric counterbalanced forklift series combines optimal comfort with cutting-edge technology that results in reduced energy consumption and longer run times.

Model	Capacity (lbs)	Voltage (V)	L x W x H	Weight (lbs)
FBC15N	3,000	36/48	78 x 37 x 86	6,270
FBC18N	3,500	36/48	78 x 37 x 86	6,790
FBC18LN	4,000	36/48	81 x 39 x 86	7,370

### • Mid-Size Electric Forklift

Our cushion tire forklift series has a comfortable operator compartment with advanced AC motor and optimized visibility.

Model	Capacity (lbs)	Voltage (V)	L x W x H	Weight (lbs)
FBC23N	4,500	36/48	82 x 41.5 x 88	8,750
FBC25N	5,000	36/48	82 x 41.5 x 88	9,100
FBC25EN	5,000	36/48	85.9 x 41.5 x 88	9,300
FBC25LN	5,500	36/48	85.9 x 43.5 x 88	9,650
FBC30N	6,000	36/48	88 x 43.5 x 88	10,600
FBC30LN	6,500	36/48	88.8 x 43.5 x 88	11,050



FBC25N

## • Stand-Up Electric Counterbalanced Forklift

The FBCS14N-FBCS18N series stand-up forklift offers a stand-up design and is ideal for confined warehouse spaces.

Model	Capacity (lbs)	Voltage (V)	L x W x H	Weight (lbs)
FBCS14N	3,000	36	63 x 41 x 88	8,424
FBCS16N	3,500	36	65 x 41 x 88	8,424
FBCS18N	4,000	36	70 x 41 x 88	9,244



FBCS16N

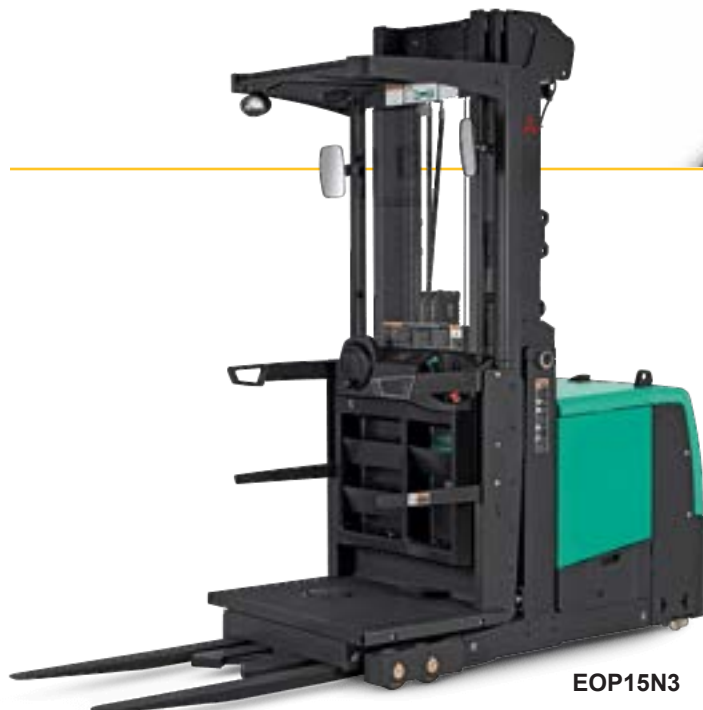

EOP15N3

## • High Level Order Pickers

The EOP15N3 high-level electric order picker forklift offers exceptional travel, lift and lower speeds through advanced 3-phase AC technology.

Model	Capacity (lbs)	Voltage (V)	L x W x H	Weight (lbs)
EOP15N3	3,000	24/36	78 x 40 x 92	7,680

## • Reach Trucks Single & Deep

A new level of performance is within your reach. Mitsubishi forklift trucks reach trucks are manufactured with advanced technology to deliver the efficiency and performance that your operation demands.

Model	Capacity (lbs)	Voltage (V)	L x W x H	Weight (lbs)
ESR15N2	3,000	36	52 x 41.5 x 95	6,826
ESR18N2	3,500	36	55 x 41.5 x 95	6,085
ESR20N2	4,000	36	55 x 41.5 x 95	6,327
ESR23N2	4,500	36	55 x 41.5 x 95	6,569
EDR18N2	3,500	36	62.3 x 42.9 x 95	6,811





## • High Level Order Pickers

With a heavy-duty frame and powder coat finish, the **PMCR27M-36M** center control rider series is built to last.

Model	Capacity (lbs)	Voltage (V)	L x W x H	Weight (lbs)
PMCR27M	6,000	24	56.9 x 35.1 x 55.7	1,895
PMCR36M	8,000	24	56.9 x 35.1 x 55.7	1,895



PMCR27M



PMT45M

## • Tow Tractor

The **PMT45M** 10,000 lb. tow tractor is designed to keep your products moving and your business moving profitable.

Model	Capacity (lbs)	Voltage (V)	L x W x H	Weight (lbs)
PMT45M	10,000	24	52.8 x 35.1 x 55.7	1,895

## • Walkie End Riders

Adaptability is key with the **PWR27M-36M** end rider pallet truck series, making it the prime solution for a wide variety of applications where you need to move more pallets in less time.

Model	Capacity (lbs)	Voltage (V)	L x W x H	Weight (lbs)
PWR27M	6,000	24	42.7 x 35.6 x 56.8	1,165
PWR36M	8,000	24	42.7 x 35.6 x 56.8	1,165



PWR36M





## • Electric Pallet Jacks

Ideal for indoor applications with confined spaces, the **PW23-PW30** motorized pallet truck series with short battery box can maneuver in even the most congested areas.

Model	Capacity (lbs)	Voltage (V)	L x W x H	Weight (lbs)
PW23	4,500	24	19.1 x 28.3 x 29.5	926
PW23	4,500	24	22.8 x 28.7 x 29.5	941
PW30	6,000	24	24 x 28.7 x 29.5	1,193



PW23



PWR30

## • Walkie End Riders

Adaptability is key with the **PWR30/PWR40** end rider pallet truck series, making it the prime solution for a wide variety of applications where you need to move more pallets in less time.

Model	Capacity (lbs)	Voltage (V)	L x W x H	Weight (lbs)
PWR30	6,000	24	42.3 x 35.8 x 58	2,730
PWR40	8,000	24	42.5 x 35.8 x 58	3,030

## • Light-Duty Walkie Stackers

The **PWF11 and PWT11** light-duty walkie pallet stacker provides added control along with a crawl speed function that allows the operator to pinwheel in tight spaces.

Model	Capacity (lbs)	Voltage (V)	L x W x H	Weight (lbs)
PWF11	2,200	24	20.5 x 31.5 x 76/96	1,235
PWT11	2,200	24	20.5 x 31.5 x 78/96	1,334



PWF11

PWT11

## • Heavy-Duty Walkie Stackers

The **PWT13-PWT18** straddle stackers offer precise control when traveling at any speed and when retrieving or putting away loads.

Model	Capacity (lbs)	Voltage (V)	L x W x H	Weight (lbs)
PWT15	3,000	24	35.8 x 31.5 x 77	2,527
PWT18	3,500	24	35.8 x 31.5 x 77	2,527



PWT18



## • Small IC Pneumatic Forklift

The **FG15N-FG35N / FD20N-FD35N** LP/gas and diesel forklift series delivers superior lift and travel speeds, powerful acceleration and the ability to move more product.

Model	Basic Capacity (lbs)	Max. Fork Height	L x W x H	Weight (lbs)
FG15N	3,000	131	89 x 41.9 x 82.7	5650
FG18N	3,500	131	90.4 x 41.9 x 82.7	6070
FG20N / FD20N	4,000	131.5	98 x 45.3 x 82.9	7,370 / 7,610
FG25N / FD25N	5,000	131.5	100 x 45.3 x 82.9	7,990 / 8,210
FG28N / FD28N	5,500	130.5	104 x 50.2 x 83.7	9,090 / 9,330
FG30N / FD30N	6,000	130.5	107 x 50.2 x 83.7	9,400 / 9,640
FG33N / FD33N	6,500	131.5	108 x 50.2 x 83.7	10,150 / 10,390
FG35N / FD35N	7,000	131.5	110 x 50.8 x 84.3	10,340 / 10,590



FG25N

FG50N



## • Mid Size IC Pneumatic Forklift

The **FGC35K-FGC70K** LP/gas Class IV forklift truck series meets strict emissions standards, while the forklift's engine continues to operate at top performance levels.

Model	Cap (lbs)	L x W x H	Weight (lbs)
FG40N / FD40N	8,000	118 x 55.7 x 90.5	12,920 / 13,050
FG45N / FD45N	9,000	123 x 57.5 x 90.5	13,820 / 13,960
FG50CN / FD50CN	10,000	125 x 57.5 x 90.5	14,970 / 15,100
FG50N / FD50N	11,000	130 x 57.5 x 90.5	15,960 / 16,090
FG55N / FD55N	12,000	132 x 57.5 x 90.5	16,690 / 16,840

## • Large IC Pneumatic Forklift

The heavy duty **FD70N1, FD100N-FD160AN** diesel forklifts series, delivers the power and performance needed for the most demanding material handling applications. Built to handle heavy loads and deliver the power and performance that tough applications demand.

Model	Basic Cap (lbs)	L x W x H	Weight (lbs)
FD70N1	15,500	141 x 85.4 x 103	20990
FD100N	22,000	177 x 99 x 119	32280
FD120N	26,500	178 x 99 x 119	34580
FD135N	30,000	179 x 103 x 121	38930
FD150AN	33,000	191 x 103 x 121	40,230
FD160AN	36,000	199 x 104 x 121	42170



FD150AN



## • Small IC Cushion Forklift

Quality components and easy maintenance give the **FGC15N-FGC33N** internal combustion forklift series the strength to perform, shift after shift.

Model	Basic Capacity (lbs)	Max. Fork Height	L x W x H	Weight (lbs)
FGC15N	3,000	131	82.3 x 38.2 x 80.9	6070
FGC18N	3,500	131	83.5 x 38.2 x 80.9	6450
FGC20CN	4,000	131	85.8 x 40.2 x 80.9	7010
FGC20N	4,000	131.5	90.4 x 41.9 x 81.5	7360
FGC25N	5,000	131.5	92.7 x 41.9 x 81.5	8,160
FGC30N	6,000	130.5	96.7 x 43.9 x 81.5	9490
FGC33N	6,500	131	97.8 x 43.9 x 81.5	9,940



FGC25N

## • Mid Size IC Cushion Forklift

The **FGC35K-FGC70K LP/gas** Class IV forklift truck series meets strict emissions standards, while the forklift's engine continues to operate at top performance levels.



FGC40K

Model	Basic Capacity (lbs)	Max. Fork Height	L x W x H	Weight (lbs)
FGC35K	7,000	120	98.8 x 46.5 x 86.8	11550
FGC40K	8,000	120	100.4 x 46.5 x 86.8	12280
FGC45K C	10,000	114	103 x 46.5 x 86.8	14260
FGC55K	12,000	114	115 x 52 x 86.8	15850
FGC60K	13,500	93	116 x 56.7 x 88.8	19,310
FGC70K	15,500	93	116 x 56.7 x 88.8	20900

## • Hand Pallet Jack

These manual walkies have a capacity of up to 5,500 lbs. and are often used to move palletized loads over short distances (less than 100 feet). The hydraulic pallet jacks are equipped with a reinforced, ergonomic handle, making it an easy task to move heavy loads.

Model	Basic Capacity (lbs)	Dimensions	Wheels
A500001662	5,500	27" x 48"	Polyurethane
A500002276	5,500	20" x 48"	Polyurethane
A500002278	5,500	20" x 36"	Polyurethane
A500002280	5,500	27" x 36"	Polyurethane



A500001662

## JUNGHEINRICH INDUSTRIAL PRODUCTS

Jungheinrich offers electric counterbalanced forklifts, narrow aisle lift trucks and walkie forklifts featuring exceptional efficiency and advanced technology. With capacities ranging from 2,000 to 15,400 pounds, Jungheinrich ranks as one of the world's leading brands of material handling equipment.

- **3-wheel Electric Pneumatic**

Excellent performance, high efficiency and incredible maneuverability — all in one package. These are the key advantages of the Jungheinrich® rear-drive 3-wheel counterbalanced truck.

Model	Capacity (lbs)	Voltage (V)	L x W x H	Weight (lbs)
EFG 110	1,920	24	63.9 x 39.0 x 82.3	5,490
EFG 113	2,400	24	68.1 x 39.0 x 82.3	6,085
EFG 115	2,880	24	70.3 x 39.0 x 82.3	6,327
EFG 213	2,510	48	69.8 x 41.7 x 80.4	5,947
EFG 216	3,100	48	78.5 x 41.7 x 80.4	6,627
EFG 218	3,490	48	78.5 x 44.1 x 80.4	6,957
EFG 220	3,880	48	78.5 x 44.1 x 80.4	7,343



EFG110



EFG220

- **4-wheel Electric Pneumatic**

Our four-wheel trucks with a high mounted full floating axle really come into their own. The fully floating axle helps minimize vibrations to the operator while providing terrain-ability and excellent operational stability on uneven surfaces.

Model	Capacity (lbs)	Voltage (V)	L x W x H	Weight (lbs)
EFG 316	3,100	48	82.6 x 41.7 x 80.4	6,503
EFG 318	3,490	48	82.6 x 44.1 x 80.4	6,812
EFG 320	3,880	48	82.6 x 44.1 x 80.4	7,175
EFG 425	4,928	80	96.1 x 47.2 x 88.2	10,311
EFG 430	5,917	80	96.3 x 47.2 x 88.2	11,303
EFG S30	6,608	80	96.3 x 51.2 x 88.2	11,876



EFG320



EFG320

- **Stand-up Counterbalanced**

The ETG Series of stand-up counterbalanced lift trucks are strong enough to handle a wide range of fast-paced, real world industrial applications — and customizable enough to fit the needs of the most demanding operator.

Available in 3,000 – 4,000 lb. capacities, these, 36-Volt AC lift trucks set the industry standard — reaching lift heights of up to 276 inches.

Model	Capacity (lbs)	Voltage (V)	L x W x H	Weight (lbs)
ETG214	3,000	36	63.0 x 41.0 x 88.0	8,424
ETG216	3,400	36	65.0 x 41.0 x 88.0	8,424
ETG318	4,000	36	70.0 x 41.0 x 88.0	9,244



ETG216

## • Low-Level Order Picker

The **EKS110** was designed for efficient low-level order picking – typically up to the 2nd, 3rd or 4th level of racking in an application. The operator platform can be raised up to a height of 118”, allowing for picking up to a height of 181” (allowing 63” of height to arms reach for the average sized operator). The counterbalanced design allows for a wide range of load storage units to be raised off the ground.

The load section is available with an open platform or with a mini mast, without reducing the residual capacity of the truck. Depending on the weight of the products being picked, the mini mast (or auxiliary lift) design is a more ergonomically correct way for the operator to pick product, increasing comfort and reducing operator fatigue.

There are multiple applications that are well-suited for the EKS 110 Series:

- Floor level and multi-rack level picking
- Expansion of pick cells to 2nd- 4th level
- Picking in narrow aisles
- Picking very small items
- Picking certain bulky items
- Picking faster-moving items



EKS110 (E)

EKS110 (ZZ)

Model	Max Fork Height	Max Pick Height	Voltage	Capacity (lbs)
EKS 110-100E*	39.4"	110.2"	24	2,200
EKS 110-160E*	63.0"	133.9"	24	2,200
EKS 110-190E*	74.8"	145.7"	24	2,200
EKS 110-280ZZ	110.2"	181.1"	24	2,200

\* No overhead guard or side gates as standard.

## • High-Level Order Picker

### EKS314

Offering high throughput performance, the EKS 314 high-level order picker sets new standards in ergonomic design, efficiency and performance. With a load capacity of up to 3,000 lbs. and order picking heights up to 366”, this truck is specifically designed for high pick rate and high density storage applications.

### EKS414s

The powerful and efficient EKS 414s high-level order picker provides peak performance in narrow-aisle applications. Equipped with an innovative, seamless simplex 3-stage mast, the EKS 414s offers the tallest light height among all vertical order pickers on the market reaching picking heights of over 45 feet and a 25 percent faster lift speed over the previous generation.



EKS414s

Model	Lift Height	Max Pick Height	Voltage	Capacity (lbs)
EKS314	327.0	238.0	24 / 36	3,000
EKS414s	290.2	269.5	48	3,000

## • Pantograph Reach Truck

The ETR 230 / 235 / 340 / 345 single reach trucks and ETR 335d deep reach trucks boast strong performance – moving more pallets per hour and lowering overall cost of ownership – while keeping operators comfortable and productive. One of the fastest in the industry, these 3,000-4,500 lb. capacity trucks are equipped with a hydraulic system that reaches a lifting speed of up to 160 feet per minute – helping your operators move more pallets in less time.

Model	Capacity (lbs)	Voltage (V)	Reach Stroke (in)	Weight (lbs)
ETR230	3,000	36	24	8,850
ETR235	3,500	36	24	8,850
ETR340	4,000	36	24	9,050
ETR345	4,500	36	24	9,050
ETR335D	3,500	36	42	9,400

(D) Deep Reach



ETR335D



ETV216

## • Moving Mast Reach Truck

The ERC214/216 electric fork-over stand-on forklift stacker combines the maneuverability of a pedestrian stacker with the option to work comfortably and quickly as a ride-on forklift truck. This series is equipped with a modern 3-phase AC drive motor, offering you greater performance while simultaneously reducing operating costs.

Model	Capacity (lbs)	Voltage (V)	Max Pick Height	Weight (lbs)
ETM214	3,000	48	244	6,545
ETV214	3,000	48	244	6,600
ETM216	3,500	48	244	6,842
ETV 216	3,500	48	244	6,899

## • Fork-over Stand-on Stacker

The ERC214/216 electric fork-over stand-on forklift stacker combines the maneuverability of a pedestrian stacker with the option to work comfortably and quickly as a ride-on forklift truck. This series is equipped with a modern 3-phase AC drive motor, offering you greater performance while simultaneously reducing operating costs.

Model	Capacity (lbs)	Max Pick Height	Voltage	Lift Height
ERC214	3,000.0	114.2	24	132.9
ERC216	3,500.0	110.2	24	130.9



ERC214

ERC216

### • Walkie Pallet Truck

Designed for loading and unloading trailers and transporting loads over short distances, the EJE120 walkie pallet trucks are ideal for high-volume distribution, ramp loading and transporting of heavy loads. The 4,500-capacity walkie feature stepless speed control and roll-back protection on ramps.

A newly redesigned compact chassis, innovative control handle and a variety of battery options make the EJE series of walkies from Jungheinrich® the premier choice in applications ranging from tight trailer loading to heavy goods transport. The EJE120 with short battery box and compact drive unit features a head length of only 19.1 inches, allowing it to maneuver in extremely confined spaces. Features such as the crawl speed button allow travel even with the handle in the raised / vertical position.

Model	Capacity (lbs)	Voltage (V)	Charge Time (hr)	Fork Length (in)	Weight (lbs)
EJE120	4,500	24	3.5	45.3	926

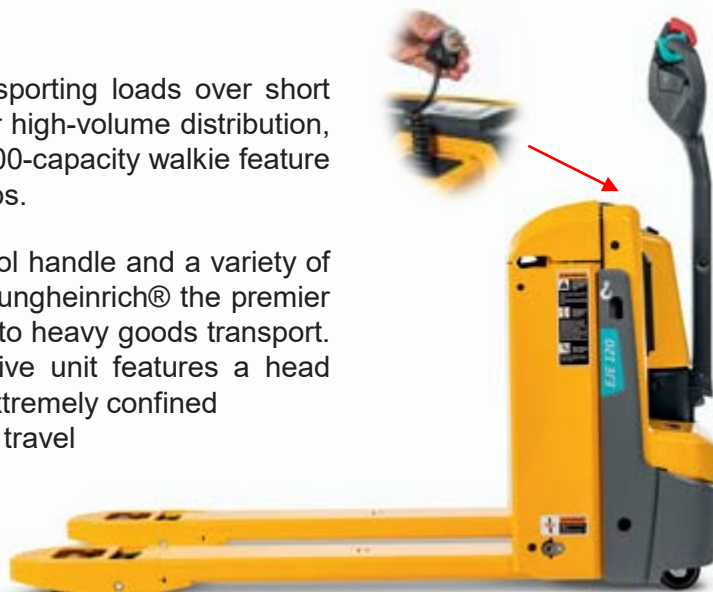

EJE120

### • Walkie Pallet Truck

The 6,000 and 8,000 lb. series of walkie end riders provides top performance for transport, order picking and dock operations. Built for high throughput and moving heavy loads, the ECR series offers hour after hour of productive operation. The fastest end rider in the industry, achieving speeds up to 9.3 mph, the ECR delivers exceptional acceleration with its high output controller and optimal programming.



ECR327

Model	Capacity (lbs)	Voltage (V)	Travel Speed (mph)	Fork Length (in)	Weight (lbs)
ECR327	6,000	24	7.1	48	2,730
ECR336	8,000	24	6	48	3030

### • Walkie Straddle And Fork-over Stacker

The EMC110/ EMCB10 electric walkie stacker combines productivity, efficiency and operator security in one user-friendly design. It is well-suited for use in a wide variety of short lift height applications, including lifting raw materials to feeder machines and stacking palletized loads onto first-level racking. In addition, it excels as an ergonomic aid, allowing materials and goods to be raised or lowered to comfortable, operator friendly working heights.

Model	Stacker Type	Capacity (lbs)	Lift High (in)	Voltage	Weight
EMC110	Fork Over	2,200	60.6	24	1,207.0
EMCB10	Straddle	2,200	60.6	24	1,479.0



EMC110

EMCB10

## Parts Fast or Parts Free

Caterpillar<sup>®</sup> Lift Trucks and Jungheinrich<sup>®</sup> are committed to providing industry-leading customer service. The Parts Fast or Parts Free Guarantee ensures next day delivery of parts, or they are free, including freight.

The Parts Fast or Parts Free Guarantee ensures next day delivery by 5:00 p.m. of parts or they are free, including freight, in the United States. For Canada and Mexico, it ensures the shipping of parts within 24 hours from the time the order was placed. This guarantee is extended to the owner of a lift truck doing business with an authorized Caterpillar<sup>®</sup> and Jungheinrich<sup>®</sup> dealer.

To qualify for the guarantee, orders must be placed through your local dealer by 5:00 p.m. Eastern Standard Time, and you must advise the dealer at the time of order that the part is to be expedited under the terms of the guarantee. Qualifying parts include any stocked Caterpillar<sup>®</sup>, Jungheinrich<sup>®</sup> or Promatch<sup>®</sup> part in the United States.

There are some exclusions, including parts over 100 lbs and paint, chemicals or lubricants that require special handling. Made-as-ordered and special sourced parts do not apply to the guarantee. Ask your dealer for a full list of terms and conditions for the Parts Fast or Parts Free Guarantee.



For general parts questions, please contact us 786-209-0228 or e-mail us at [forkliftparts@kellytractor.com](mailto:forkliftparts@kellytractor.com)



### NARROW AISLE FORKLIFTS

Aisle Master has a vast range of experience in providing cost-effective solutions to materials handling problems. You can be sure of peerless quality and support when buying any Aisle Master articulated forklift truck.

Our machines are built at our site in Monaghan, Ireland – also home to our parent company Combilift. A state-of-the-art production line, plus extensive R&D facilities enable us to pursue our aim of continual product enhancement, thus giving our customers nothing but the best. There are now over 57,000 units working around the world in locations as varied as Alaska and Australia, supported by a network of distributors and factory trained engineers to ensure service and after sales back up is fast and effective.

- **AC Electric Machine**

All Aisle Master's electric powered models now benefit from AC technology as standard. This puts the company firmly at the forefront of battery powered technology in the articulated sector.

The main benefits of AC electric include enhanced performance levels, leading to increased pallet movements for greater productivity and improved acceleration and gradeability. There are also fewer wearable parts resulting in low maintenance and reduced downtime.



- **Aisle Master LPG**

Aisle Master is acknowledged as the pioneer of LPG power in the articulated forklift sector. Aisle Masters are fitted with a closed loop fuel system as standard, to improve emissions and fuel economy whilst a specially designed engine bay cooling system ensures the effective running of the engine for maximum uptime and reliability.

The main benefit of LPG is reduced emissions levels, ideal for indoor and outdoor operation, making it useful for trucks that are used in almost all industries, even the most emission conscientious. LPG power also offers 24/7 operation with no loss of power.



### • Cold Store Aisle Master

The cost of cold store and temperature controlled warehousing operations is much higher than that of ambient warehousing, making space saving more crucial than ever. Aisle Master's cold store model keeps you warm and productive in a cold climate.

Collaboration with some of the major names in the industry resulted in a model developed specifically for this sector's exacting requirements whilst guaranteeing optimum storage density. The fully enclosed, high visibility cab keeps drivers warm, reducing the time needed for breaks and increasing productivity.

- Heated cab windows eliminate the build-up of condensation when driving between different temperatures in a building
- Allocated areas in the cab enable the use of a bar code scanner
- Low energy LED work lights as standard

### • Aisle Master Order Picker

The NEW Aisle Master-OP (AME-OP) is a stand-on electric powered model that combines the advantages of a narrow aisle articulated forklift and an order picker for versatile operation in warehousing applications.

The main benefits of AC electric include enhanced performance levels, leading to increased pallet movements for greater productivity and improved acceleration and gradeability. There are also fewer wearable parts resulting in low maintenance and reduced downtime.





Kalmar provides cargo-handling solutions and services to ports, terminals, distribution centers and heavy industry. We are the industry forerunner in terminal automation and energy-efficient container handling; one out of every four container moves around the globe is handled by a Kalmar solution. We improve the efficiency of every move through our extensive product portfolio, global service network, and solutions for seamless integration of terminal processes.

- **Forklift Trucks 22,000-40,000 lbs.**

The Kalmar DCG100–180 forklift truck is designed to offer you the best possible return on investment over its entire lifespan. Ideal for demanding applications such as steel and wood handling, this next-generation forklift combines low fuel consumption and superior lifting performance with easy maintenance and excellent reliability.



DCG120-6

- **Forklift Trucks 40,000-117,000 lbs.**

The Kalmar DCG180–540 is our range for the most challenging lifting operations; Kalmar's heavy-duty forklifts offer everything you need. These powerful, reliable trucks are trusted by customers all around the world for their reliability, flexibility, and precision in a wide variety of terminal and heavy-industry applications.



DCG250-12

- **Forklifts Trucks 132,000-158,500 lbs.**

Introducing a powerful and versatile heavy lifter, the new Kalmar Super Heavy Forklift truck. Capable of shifting extreme loads of up to 158,500 lbs., it handles your heaviest loads with ease. Ideal for steel, concrete and other heavy industries.



DCG680-12

- Empty Container Handler Range

You can expect more from Kalmar **DCG80-100** new range of empty container handlers. Our new range of empty container handlers are based on the experience and accumulated knowledge of building more than 10,000 machines over the last 30 years, so you get the most robust, reliable and efficient machine that we have ever built. You will also have more choice with the broadest range of empty container handlers for you to choose from. Which is why we say - you can expect more.

Double stackers, up to 22,000 lbs, high mounted cabin.



Single stackers, up to 22,000 lbs, low mounted cabin.

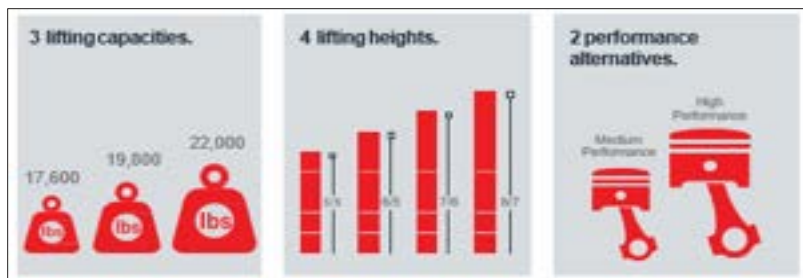



## • Loaded Container Handlers

Kalmar solutions are known for their reliability and durability and our new top loader is no exception. The top loader's chassis is mechanically welded and optimized according to three main parameters: strength, weight and stability. In addition, the machine's stability has been improved by creating the perfect balance between the counter-weight and the lifting height. We also go to great lengths to make sure that the systems and components fitted to our top loaders are made to last.

The result of bringing together improved stability, an optimized chassis and components and systems that are manufactured to last will deliver a much more robust and durable machine that is ready to get to work.



### Improved visibility.

A-posts have been replaced with slim B-posts, to provide greater visibility in all directions: forward, rearward, upward and to the side.

Our combined roof/front wiper system cleans a bigger area of the front windscreen and the transparent roof than before, making sure your forward and upward view stays extra clean and clear at all times.



### Minimize driver fatigue.

With levers or an optional joystick, electronically adjustable work console and side tilt steering wheel, the controls and settings are all designed to minimize driver fatigue and maximize operational efficiency.



### More comfortable.

With an adjustable driver's seat, quieter cabin and climate control system with smarter controls, your driver will benefit from improved ventilation, heating and cooling, plus a cabin with superior interior comfort. An optional cabin air intake precleaner can also be fitted if required.



### An improved user interface.

Our user interface combines sight, sound and touch to create a perfectly balanced operating environment with a new color display at its heart. Advanced diagnostics allows for greater operational control and safety.



DCG400GS



Kalmar reachstackers are designed to help your operations – and your entire business – reach new heights of productivity. Combining our extensive experience in material and container handling with our innovative cargo-handling technology, Kalmar reachstackers offer high performance throughout the entire operating cycle, user-friendly operation, low running costs, and excellent environmental performance.

- **Empty and Semi-laden Reachstacker**

Everything within empty and semi-laden container handling. With the Kalmar **DRG100-120** you can handle all types of containers (standard ISO, reefers, tanks, specials and flat racks) and slinged loads up to 12 tones precisely and safely. It also offers the rotation necessary for efficient action in confined spaces. Plus, you get the quality that makes your business prosper, both in the short and long term.



DRG100



DRG420

- **Gloria Reachstacker**

Our Gloria reachstacker is the result of all the years of experience we've gathered ever since we pioneered the world's first commercial reachstacker. Now we've taken it a step further, increasing efficiency and reducing downtime. Because the most important thing we've learned through all these years is that it all comes down to one thing: keeping your business on the move, no matter what.

- **Loaded Reachstacker**

Built on our tested and proven G-Generation platform our new 45-57 ton reachstackers will deliver everything you expect from Kalmar, for a great price.

There are three container handlers available, with different lifting capacities in the second and third row, and an industrial machine that can lift loads up to 57 tones with a hook. With a range of highly efficient driveline combinations to choose from, you can expect to use less fuel and produce less emissions. Up to 10% less.



DRU450

### ROUGH TERRAIN FORKLIFTS

A third generation, family-owned business, HARLO Products has been serving the vertical mast rough terrain forklift industry since the early 1940s. For decades, the HARLO name has been synonymous with quality and dependability.

HARLO continues to build rough terrain forklifts to meet a variety of modern needs, while holding on to our traditional values. HARLO owners know that when buying a HARLO forklift, they will receive the highest return on their investment.

The HP Series of forklifts has everything you would expect of a rough terrain forklift, and more. With low-end torque, and increased lift capacity, your HARLO will make you more efficient, thus more profitable. Our forklift's heavy gage all steel construction paired with our knowledgeable service department ensures your forklift will remain effective and spend more time on the job for years to come.



Model	HP5000	HP6500	HP8500
HT Top Overhead Guard	94"	102"	102"
Wheel Base	83"	87"	87"
Drive Tread Width	62"	68"	68"
Steer Tread Width (2WD / 4WD)	71" / 67"	71" / 67"	71" / 67"
Underclearance	15"	15"	15"
Mast Tilt (FWD/REV)	11° / 15°	33° / 11°	33° / 11°
Overall Width	79"	84"	84"
Overall Length	149"	150"	152"
Lifting Capacity (lb)	5000	6,500	8500
Available Engines	John Deere 4045TF290 Cummins 4.5L Electric Fuel Inj.	John Deere 4045TF290 Cummins 4.5L Electric Fuel Inj.	John Deere 4045TF290 Cummins 4.5L Electric Fuel Inj.
Mast Options Available (ft)	12' - 2 Stage 14' - FreeLift - 3 Stage	10' - 2 Stage 11' - 3 Stage 15' - 2 Stage 22' - 3 Stage 28' - 3 Stage 20' - FreeLift - 3 Stage	15' - 2 Stage 16' - 3 Stage 22' - 2 Stage 20' - FreeLift - 3 Stage

## USED LIFTS TRUCKS AND ARIAL EQUIPMENT

From 3,000 to 120,000 Lb. Capacity Reconditioned And Non-reconditioned Units Always In Stock

Kelly Tractor Co.'s Industrial Lift Division offers one of the largest selections of Used Equipment in South Florida. Our knowledgeable staff can assist you in purchasing the right machine for your business.

If we are not currently stocking the item, we can find it. From narrow aisle trucks to large container handling machines, you can depend on us to meet all your lift truck needs.



Full & Empty Container Handlers



Used Forklifts



Used Aerial Equipment

Our used equipment sales representatives can assist you in selecting the right machine from our inventory. Many of our low hour, late model machines are from our own rental fleets, where they are maintained by trained technicians.

Whether you are right around the corner or around the world, our representative can coordinate the delivery of your used equipment purchase right to your doorstep.

To search our large inventory of used equipment, visit [www.kellytractor.com](http://www.kellytractor.com) and click on the "New/Used Equipment" button on left center of the Home Page.

### Export Sales

**Christopher Alvarez** (Se habla Español)

Cell: 786-400-9014

Direct: 305-423-0053

Fax: 305-463-6063

[Christopher.Alvarez@kellytractor.com](mailto:Christopher.Alvarez@kellytractor.com)







## AERIAL EQUIPMENT

JLG Industries, Inc. has been earning customer confidence and trust through innovation since 1969. Our customers are our greatest priority, and we remain steadfast in our commitment to understanding their challenges.

We deliver the powerful, versatile equipment they need along with unsurpassed training and service, because we have a responsibility to be more than a manufacturing company. We are a partner in our customer's success, reaching out worldwide to enable performance, boost productivity, ensure uptime and support forward progress.

### • Telescopic Boom Lift

When you need to work around different angles on crowded job sites, it's important to have the right piece of equipment to get you straight to the source. JLG® engine powered telescopic boom lifts are ideal for work that requires extended horizontal and vertical outreach. Our telescopic lifts take you right where you need to work while providing you with the height and capacity you need.

Model	Working Height Max (ft)	Horizontal Reach (ft.)	Overall With (ft)	Lift Capacity Rest/Unrest. (lbs)
400S	40.0	33.3	7.7	600/1000
600S	59.8	50.2	8.2	600/1000
800S	80.0	71.0	8.2	500/1000
1200SJP	120.0	75.0	12.6	500/1000
1350SJP	135.0	80.0	12.6	500/1000
1500SJ	150.0	80.0	12.6	500/1000
1850SJ	185.7	80.0	16.6	500/1000



740AJ



800A



600A



600AJ



1500AJP

### • Articulated Boom Lift

On the job site, days are measured by productivity. Your productivity. Which means you need equipment that stands up to the day's demands. JLG® engine powered articulating boom lifts give you the extra reach you need to work over and around obstacles on the job site. They offer exceptional outreach, high capacity, versatile performance and easy maintenance. The larger work envelope on an articulating lift provides you with access to those hard-to-reach places.

Model	Working Height Max (ft)	Horizontal Reach (ft.)	Overall With (ft)	Lift Capacity Rest/Unrest. (lbs)
340AJ	38.0	19.1	6.4	500/NA
450AJ	45.0	25.0	7.9	550/NA
600A	66.0	39.7	8.2	500/1000
740AJ	80.0	51.10	8.2	500/NA
800A	86.0	53.0	8.2	500/1000
1250AJP	131.0	63.2	8.2	500/1000
1500AJP	156.0	125.0	8.2	600/1000



## • Compact Crawler Booms

Compact Crawler lifts feature low weight and rubber tracks that allow you to go more places around the job site. They are environmentally friendly with standard AC power, gas or an optional lithium-ion electrical system that doesn't produce emissions. These lifts climb slopes with ease thanks to their tracked wheel carriage, and their narrow chassis allows for access through gates, yards, standard doorways and public buildings. This makes a Compact Crawler lift ideal for various jobs both indoors and out.

Model	Platform Height Max (ft)	Horizontal Reach (ft)	Overall Width (ft)	Lift Capacity (lbs)
X430AJ	43.0	21.7	2.5	500
X500AJ	49.0	23.0	2.7	500
X600AJ	59.3	30.0	2.7	500
X770AJ	77.5	43.0	3.3	500
X1000AJ	100.0	54.2	3.11	500

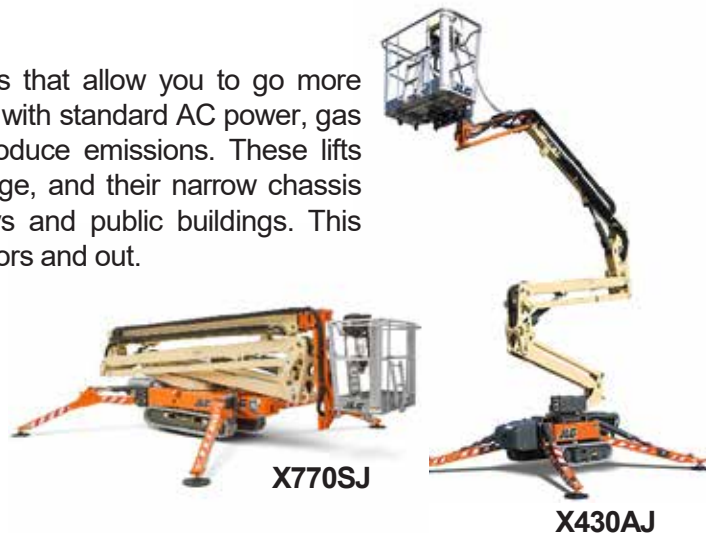

## • Articulating Boom Lifts

Today, more people are demanding environmentally friendly equipment. And more municipalities are requiring "green" building for new construction and renovations. The JLG line of electric boom lifts feature longer run time, greater uptime and higher productivity.

- Hybrid technology – Runs completely on 8 x 12v 100 amp-hour AGM batteries, which are charged by the diesel generator
- Versatility – The power of a diesel machine combined with hybrid efficiency allows you to work both inside and outside



Model	Platform Height Max (ft)	Horizontal Reach (ft)	Overall Width (ft)	Lift Capacity (lbs)
H340AJ Hybrid	33.9	19.11	6.4	500
E300AJP	29.5	20.1	4.0	500
E400AJP	40.0	22.5	5.9	500
E400AJPN	40.0	22.5	4.11	500
E450A	45.0	23.0	5.9	500
H800AJ Hybrid	80.0	51.10	8.2	500

## • Telescopic Boom Lifts

For challenging indoor and outdoor spaces where you must tackle many angles with little impact, you need a machine that delivers optimal horizontal and vertical outreach. JLG telescopic boom lifts give you the height and capacity you need along with clean operation and excellent maneuverability. With zero emissions and low noise, these machines are ideal for situations that require the fewest environmental disruptions. Longer duty cycles keep productivity high from start to finish.

Model	Platform Height Max (ft)	Horizontal Reach (ft.)	Overall Width (ft)	Lift Capacity (lbs)
E600J	60.3	43.3	7.11	500
M600J	60.3	43.3	7.11	500
E600JP	60.4	44.5	7.11	500
M600JP	60.4	44.5	7.11	500

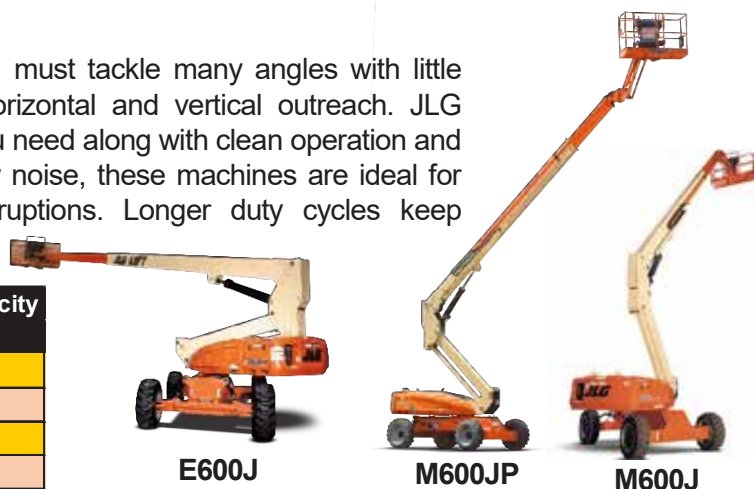



## SCISSOR LIFTS

### • Electric Scissor Lifts

Get more uptime and less recharging with JLG® electric scissor lifts. These machines are designed so you have fewer scheduled services, a quieter work area, less dependency on hydraulic oils and zero emissions. Also, the innovative operator controls and compact dimensions make this series extremely mobile. Boost productivity and operator confidence on the job by choosing an electric man lift from JLG.

Model	Working Height Max (ft)	Overall With (ft)	Turning Radius	Lift Capacity (lbs)
1932R	25.0	2.80	5.6	550
ES1932i	25.0	2.67	5.6	507
ES1932	25.0	2.67	5.6	507
4045R	45.3	3.9	8.4	550
1930ES	24.9	2.6	5.9	500
2032ES	26.0	2.90	6.90	800
2632ES	31.6	2.80	6.90	500
2646ES	32.0	3.1	7.1	1000
3246ES	37.9	3.1	7.1	700
3369LE	39.0	5.9	15.6	1000
4069LE	46.0	5.9	15.6	800



3369LE



1932R

Electric & Rough Terrain Scissor Lifts

### • Rough Terrain Scissor Lifts

JLG® engine powered scissor lifts are chosen for applications that require more workspace and more lifting capacity. The LRT Series and MRT Model both provide a larger work area and generally higher load capacities than boom lifts. Both deliver exceptional terrain-ability and gradeability, making it easier to maneuver through the roughest job sites.

- Durable scissors lift and carry more thanks to enhanced power and stability
- Increased scissor lift capacities and larger platforms with more workspace
- Choose from multiple models that traverse rough terrain and tackle industrial jobs with ease



530LTR



260MRT

Model	Working Height Max (ft)	Overall With (ft)	Turning Radius	Lift Capacity (lbs)
260MRT	26.0	5.9	14.5	1250
330LRT	39.4	7.9	19.5	2004
430LRT	49.0	7.9	19.6	1500
530LRT	59.0	7.7	19.5	1500



## STOCK PICKERS

When you enlist the help of a stock picker, you can trust that you're improving efficiency, reach and safety. Using a stock picker to perform stock picking, general maintenance and other repetitive tasks allows your staff to complete their work in less time. JLG has a range of drivable stock pickers and push around stock pickers for more portable, productive solutions.

- **Push Around Stock Pickers**

Stock up on safety, performance and productivity with JLG® Push Around Stock Pickers. The large platforms accommodate up to 500 lb. and can reach up to 21 ft in working height without the need for outriggers. An advanced Point & Go® drive and steer joystick controller provides one-handed operation while leaving one hand free for increased operator comfort and efficiency.



12SP

Model	Working Height Max (ft)	Overall With (ft)	Lift Capacity (lbs)
12SP	18.0	2.10	500
15SP	21.0	2.10	500

- **Drivable Stock Pickers**

Whether you are transporting supplies, setting up displays or performing routine maintenance, the MSP Series makes your everyday tasks more efficient. Our line of stock pickers lets you carry both people and materials thanks to a flexible platform and extra-large material tray. They also feature a zero turning radius for superior maneuverability and long battery cycles for working a full shift or more.



10MSP



Model	Working Height Max (ft)	Overall With (ft)	Lift Capacity (lbs)
10MSP	16.0	2.6	350
15MSP	21.3	2.6	500
20MSP	25.5	2.6	400

## TOW-PRO BOOM LIFTS

The Tow-Pro® Series – our exclusive line of towable boom lifts – lets you tackle the same jobs as other JLG® electric or gas-powered boom lifts, but with an easier option for transportation. You have the choice of a 24V DC electric or 9 HP gas-powered engine. And with the standard combination hitch, industry-leading 65 mph towing speed and hydraulic auto-leveling outriggers, you can have this extremely portable lift brought to the job site and working in no time. Whether you need it for tree trimming, decorating, construction, exterior painting or maintenance tasks, a Tow-Pro is great for your everyday needs.

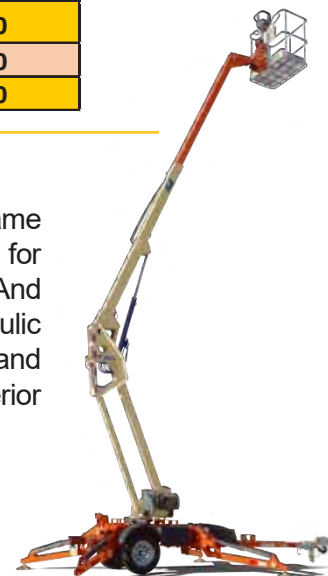

T350

Model	Platform Height Max (ft)	Overall With (ft)	Lift Capacity (lbs)
T350	34.5	4.9	500
T500J	50.0	5.7	500



## LOW-LEVEL ACCESS LIFTS

For light maintenance and facility work, low-level access satisfies your need for a safe, efficient and simple ladder alternative. JLG helps you get the job done with low-level access solutions that range from Push Arouds to the eco-friendly, non-powered EcoLifts.

### • Non-Powered EcoLift™ Series

For situations where a ladder isn't the best option for the task at hand, look to the EcoLift™ Series from JLG. The innovative lift/lower mechanism is simple to use and gives operators the confidence to tackle low-level tasks like changing light bulbs, hanging décor or accessing HVAC ductwork. EcoLifts are power-free and have no oil, batteries or hydraulics, making them an eco-friendly, non-disruptive solution for sensitive environments.

Model	Working Height Max (ft)	Overall With (ft)	Lift Capacity (lbs)
Ecolift 50	10.11	2.4	330
Ecolift 70	13.3	2.4	330



Ecolift 70

Ecolift 50



830P

### • Push Around Mast Lift

Whether you're doing finish work or routine maintenance, sometimes your toughest obstacles aren't just overhead. For your most sensitive floors, you need a lift that gives you access without weight. Our push around mast lift combines height and reach with low ground pressure for challenging tasks, with the uptime you need to finish the job.

Model	Working Height Max (ft)	Overall With (ft)	Lift Capacity (lbs)
830P	14.2	2.6	440

### • LiftPod Personal Portable Lifts

JLG® LiftPod® personal portable lifts offer facility maintenance workers a secure platform and the ability to work 360 degrees with both hands. Available in two models, these portable units lift you to heights of up to 20 ft. LiftPod personal lifts can be assembled or disassembled in just minutes, are easy to maneuver and feature a convenient tool tray. A portable man lift is a safer choice for plant and facility maintenance projects. Plus, portable lifting equipment from JLG is backed by industry-leading customer support.

Model	Working Height Max (ft)	Overall With (ft)	Lift Capacity (lbs)
FT70	13.0	2.6	330
FT140	19.6	5.4	330



FT140

FT70



## VERTICAL LIFTS

When your maintenance or repair work requires overhead reach in tight spaces, you need vertical lift solutions that deliver full access with the productivity to finish those pressing tasks. Our range of drivable and push around vertical lifts are an efficient and productive way to tackle up and over work. They're also a safer, more efficient alternative to ladders, giving you a boost of confidence on the job.

### • Push Around Vertical Mast Lifts

Virtually eliminating the need for scaffolding or ladders, JLG® push-around vertical mast lifts allow you to get closer to your overhead work and maintenance applications. You'll be able to fit through standard doorways, maneuver your way through narrow aisles and go more places than ever before. Push-around vertical mast lifts are great for general repair work, routine maintenance, managing inventory and even hanging holiday decorations.



Model	Working Height Max (ft)	Overall With (ft)	Lift Capacity (lbs)
19AMI	25.0	2.10	350
20AM	26.0	2.5	350
25AM	31.0	2.5	350
30AM	36.0	2.5	350
36AM	42.0	2.5	300
41AM	47.0	2.5	300



### • Drivable Vertical Mast Lifts

With stellar battery life, maintenance-free components and robust construction, JLG® drivable vertical mast lifts last longer and are more reliable than ever. All vertical mast lift models run on electric power thanks to a reliable electric drive. They also offer ease of operation and greater maneuverability. With mast lifts from JLG, you can get maintenance jobs done quickly and efficiently.

Model	Working Height Max (ft)	Overall With (ft)	Lift Capacity (lbs)
1230ES	18.0	2.6	500
15MVL	21.4	2.6	500
20MVL	25.1	2.6	350



### • Toucan Mast Boom Lifts

With the JLG Toucan® vertical mast lift, you can meet your overhead challenges head-on. Work up, over and around assembly lines, shelving, ductwork or partitions more easily and without interferences. These mast boom lifts feature thick rubber non-marking tires, clean and efficient electric power and 25% gradeability.

Model	Platform Height Max (ft)	Horizontal Reach (ft.)	Overall With (ft)	Lift Capacity (lbs)
T20E	20.2	6.7	3.3	500
T26E	26.5	8.8	3.9	500
T32E	32.3	15.1	3.11	500



## Drop Deck Trailers

The Triple-L® drop deck trailer from JLG allows you to load equipment at ground level without the need for cumbersome unattached ramps or tilt beds, saving you time and money while increasing operator safety during the loading process. Our exclusive Power Deck® system lowers the entire deck of the trailer to the ground for improved efficiency. Triple-L (Lower, Load, Lift) trailers are available in utility or flatbed configurations.

- **Flatbed Trailers**

The Triple-L® flatbed trailer makes it easier to load and transport equipment with features like ground-level loading, a large capacity deck and Quadra spring suspension. These models are ideal for carrying equipment with low ground clearance or poor traction, such as scissor lifts, industrial sweepers, landscaping equipment, pavers, rollers, compactors and more.

Model	Capacity	Deck Width (ft)	Deck Length (ft)	Overall Length (ft)	Weight
248	2,200	4.4	8	14	1,510
449	5,000	4.4	9	14	1,670
4610	4,500	6.0	10	15	2,070
7610	7,000	6.0	10	15	2,500
7612	7,000	6.0	12	17	2,690
7614	7,000	6.0	14	19	2,930
7616	6,500	6.0	16	21	3,150
1012	10,000	5.10	12	17	3,010
1014	10,000	5.10	14	19	3,210



UT610

- **Utility Trailers**

The Triple-L® utility drop deck trailer delivers performance and versatility for carrying equipment and supplies, with the added convenience of enclosed sides. These dual-purpose models feature full-width, low-angle ramps that enable easier loading with a handcart or dolly. Optional rails and a tailgate can be added or removed at any time for added convenience.



Model	Capacity	Deck Width (ft)	Deck Length (ft)	Overall Length (ft)	Weight
UT28	2,200	4.4	8	14	1,590
UT49	5,000	4.4	9	14	1,795
UT410	4,500	6.0	10	15	2,220
UT610	7,000	6.0	10	15	2,650
UT612	7,000	6.0	12	17	2,850
UT614	6,500	6.0	14	19	3,050
UT912	10,000	5.10	12	17	3,170
UT914	10,000	5.10	14	19	3,370

## AERIAL EQUIPMENT

For more than 50 years, Genie has gone above and beyond in its product development efforts, focusing on what customers need to be successful in their industries and applications — Genie innovations change the market and set the industry standard for quality, reliability and safety in aerial lift equipment.

### • Telescopic Boom Lift

Genie® S® telescopic boom lifts are engineered to enhance working efficiency and offer greater horizontal outreach than any other type of aerial platform. Perfect for work in areas with limited access, Genie telescopic booms deliver industry-leading outreach and capacity throughout a full-working envelope for incredible operational accessibility.

Model	Working Height Max (ft)	Horizontal Reach (ft.)	Overall With (ft)	Lift Capacity (lbs)
S-40XC	46.0	31.8	8.2	660 / 1000
S-45XC	51.0	36.2	8.2	660 / 1000
S-60XC	66.0	50.1	8.2	660 / 1000
S-65XC	71.0	54.2	8.2	660 / 1000
S-80XC	86.0	68.6	8.2	660 / 1000
S-85XC	91.0	74.6	8.2	660 / 1000
SX-105XC	111.0	80.0	12.11	660 / 1000
SX-125XC	131.0	80.0	12.11	660 / 1000
SX-135XC	141.0	90.0	12.11	660 / 1000
SX-150	157.0	80.0	16.6	750
SX-180	186.0	80.0	16.6	750



### • Articulated Boom Lift

Genie® Z® articulating boom lifts provide the ability to lift up, over and out with precise positioning for ultimate versatility in hard-to-access work areas. Genie introduced the articulating Z-boom in 1985 with the Genie Z-30/20 model; a product that launched the company into the rental segment. These lifts gained incredible popularity due to their unique “up-and-over” capabilities to navigate obstacles at height.

Model	Working Height Max (ft)	Horizontal Reach (ft.)	Overall With (ft)	Lift Capacity (lbs)
Z-34/22 IC 2WD	40.6	22.3	5.8	500
Z-34/22 IC 4WD	40.10	22.3	6.1	500
Z-45XC	51.6	24.9	7.6	660/1000
Z-62/40	67.11	40.5	8.2	500
Z-80/60	84.0	60.0	8.2	500
ZX-135/70	141.0	69.9	8.2	600

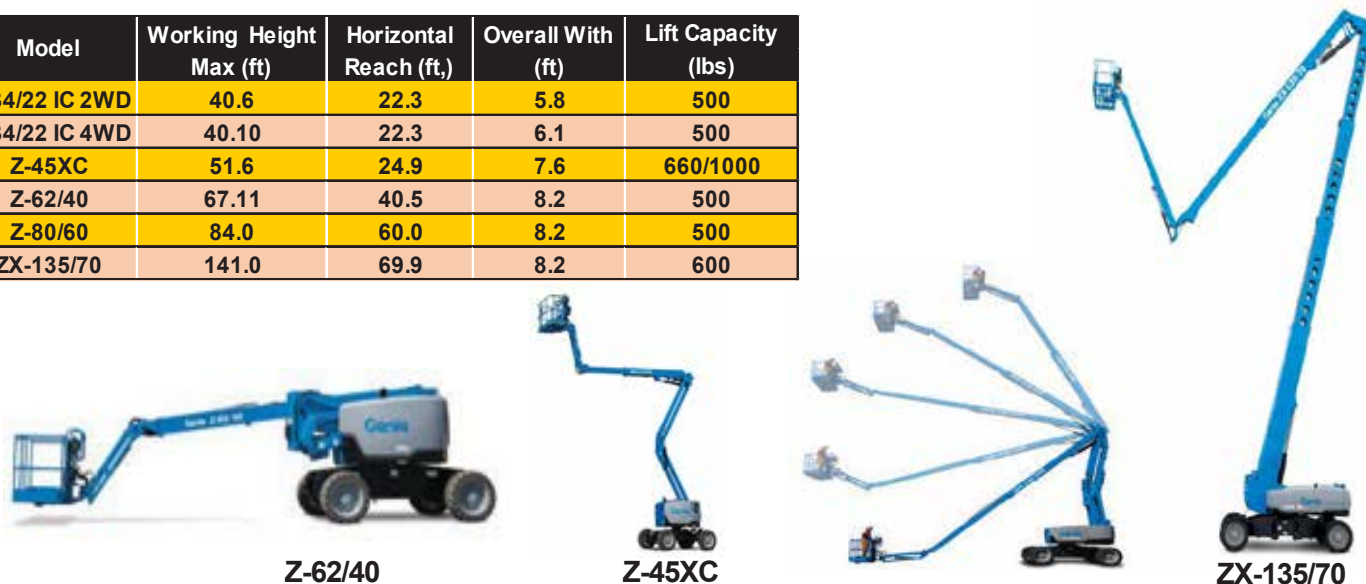





## • Electric & Bi-Energy Lifts

Genie® DC and Bi-Energy machines offer quiet, emission-free operation in the most sensitive work environments. For industrial applications where the machine must be driven significant distances, the Genie bi-energy system combines the benefits of a 48V DC machine with the versatility of a diesel-powered generator.

### Z-34/22 DC or Bi Energy

The Genie® Z®-34/22 electric articulating boom lift offers quiet, emission-free operation in the most sensitive work environments. It's a 48V DC machine with a diesel-powered generator acting as a 100-amp battery charger, making it ideal for indoor and outdoor applications.

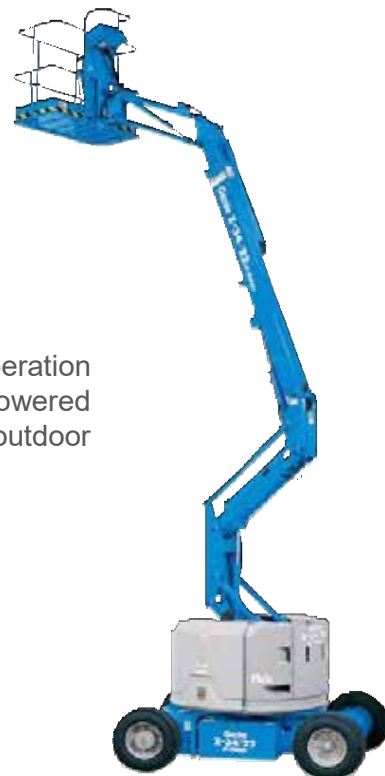

Z-34/22 (Bi-Energy)

Model	Working Height Max (ft)	Horizontal Reach (ft)	Overall Width (ft)	Power Source
Z-30/20N	36.0	21.5	3.11	48V DC
Z-30/20N RJ	35.2	20.6	3.11	48V DC
Z-33/18	39.4	18.3	4.11	48V DC
Z-34/22 DC & Bi	40.6	22.3	5.80	48V DC / Kubota 13.3 hp
Z-40/23N	46.5	22.8	5.80	48V DC
Z-40/23 RJ	46.5	22.8	5.80	48V DC
Z-45/25J DC & Bi	51.9	25.1	5.00	48V DC / Kubota 13.3 hp
Z-60/37J DC&FE	65.7	36.7	8.20	48V DC

## • Trailer Mounted Boom Lifts

With easy-to-travel mobility, Genie® TZ™ trailer-mounted boom lifts feature an outstanding operating envelope to reach jobs high and low. Offering the best of both worlds, Genie trailer-mounted booms boast the operating envelope of a Genie Z® boom — reaching up, over and out, as well as can be easily towed behind a pickup or SUV.



TZ-34/20



TZ50



Model	Working Height Max (ft)	Horizontal Reach (ft.)	Lift Capacity (lbs)	Up and Over Clearance
TZ-34/20	40.0	18.4	500	16.1
TZ-50	55.6	29.2	500	22.0



## • Slab Scissor Lifts

Genie® GS™ slab scissor lifts are exceptionally mobile, letting operators easily maneuver around tight indoor and outdoor worksites with firm, level surfaces. Characterized by low noise levels, Genie slab scissor lifts provide excellent capacity and large platform workspace.

Model	Working Height Max (ft)	Overall With (ft)	Turning Radius	Lift Capacity (lbs)
GS-1330m	18.1	30.5	5.1	500
GS-1530	21.0	2.6	5.1	600
GS-1930	25.0	2.6	5.1	500
GS-2032	26.0	2.8	7.0	800
GS-2632	32.0	2.8	7.0	500
GS-3232	38.0	2.8	7.0	500
GS-2046	26.0	3.1	7.6	1200
GS-2646	32.0	3.1	7.6	1000
GS-3246	38.0	3.1	7.6	700
GS-4047	45.0	3.1	7.7	550



GS-2646 AV



GS-1330m

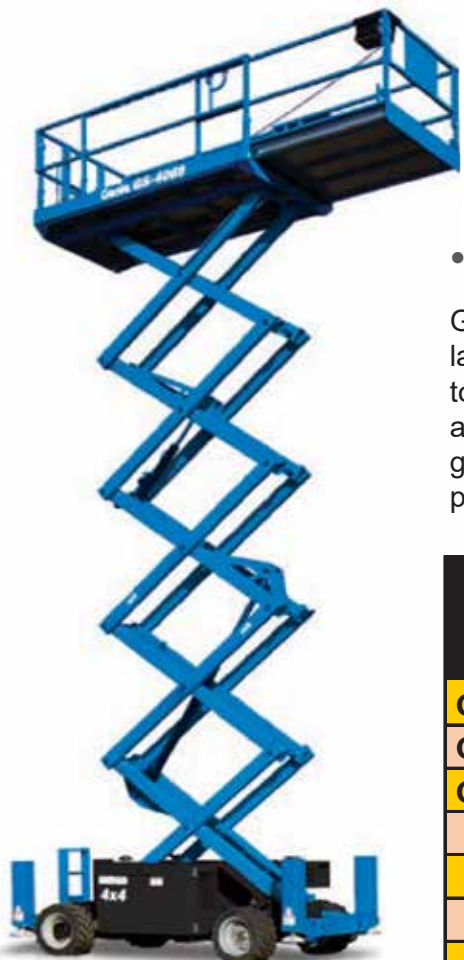

GS-4069 RT/DC

## • Rough Terrain Scissor Lifts

Genie® GS™ rough terrain scissor lifts offer competitive lift speed and large platforms to increase efficiency with the handling and capacity to get to the jobsite and finish working faster. Genie rough terrain scissor lifts also enhance productivity by providing exceptional traction, speed and gradeability. They're the perfect machines for big outdoor jobs where platform workspace is critical.

Model	Working Height Max (ft)	Overall With (ft)	Turning Radius	Lift Capacity (lbs)
GS-2669 RT/DC	32.0	5.9	15.1	1500
GS-3369 RT/DC	39.0	5.9	15.1	1000
GS-4069 RT/DC	46.0	5.9	15.1	800
GS-3384 RT	39.0	7.0	19.6	2500
GS-3390 RT	39.0	7.8	17.6	2500
GS-4390 RT	49.0	7.8	17.6	1500
GS-5390 RT	59.0	7.8	17.6	1500

## • Work Platforms

Genie® AWP™ and IWP™ aerial work platforms are easy to use and cost effective, making them the first choice for a wide range of applications. One person can easily set them up and get to work within minutes, providing the ideal all-around tool for almost any access application.

Their lightweight and compact size makes Genie aerial work platforms convenient to use in schools, churches, warehouses and more. Genie aerial work platforms also provide solutions for interior work on large construction sites, such as high rises, as well as being perfect for light-duty construction purposes.

Model	Working Height Max (ft)	Overall With (ft)	Turning Radius	Lift Capacity (lbs)
AWP-20S	26.1	2.5	20.1	350
AWP-25S	30.1	2.5	24.11	350
AWP-30S	35.6	2.5	29.6	350
AWP-36S	42.5	2.5	36.5	350
AWP-40S	46.4	2.5	40.4	350
IWP-20S	26.3	2.8	20.3	350
IWP-25S	30.1	2.8	24.11	350
IWP-30S	35.6	3.4	29.6	350

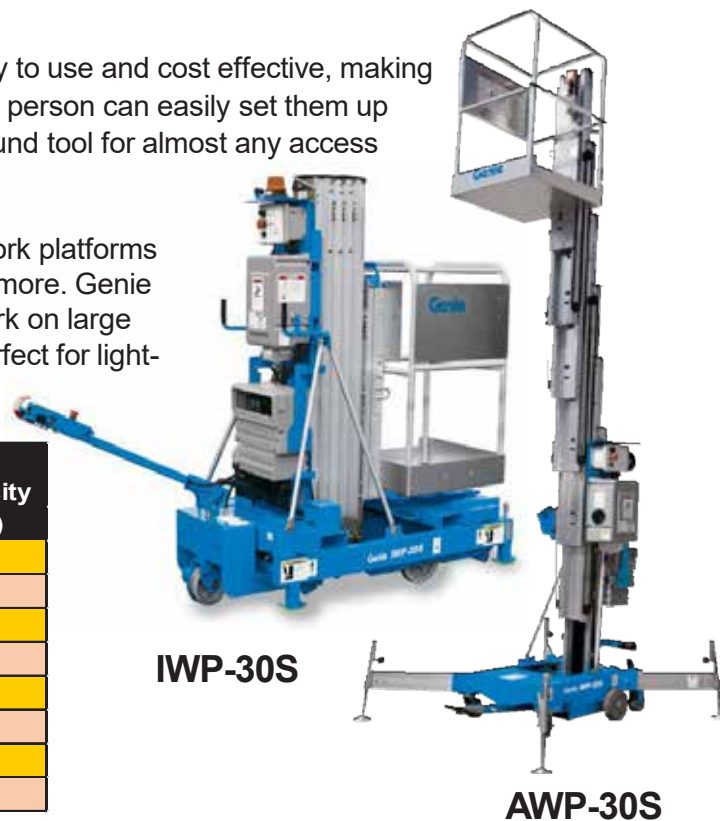

IWP-30S

AWP-30S

## • Vertical Mast Lifts

Genie® Runabout® , Runabout® Contractor and QuickStock™ aerial work platforms are designed to enhance productivity in the workplace. Flexible features on the Genie GR™, GRC™ and QS™ models offer convenience at a low cost.

Their lightweight construction makes them easy to maneuver, use and transport, delivering excellent uptime. Each model offers a variety of options and accessories to customize the machine to match the application. Genie aerial work platforms offer an economical solution for all operators' access needs.



QS-15



GR-20

Model	Working Height Max (ft)	Overall With (ft)	Turning Radius	Lift Capacity (lbs)
GR-12	17.4	2.6	11.4	500
GR-15	20.8	2.6	14.8	500
GR-20	25.9	2.8	19.9	350
GR-26J	31.1	3.9	25.11	500
GRC-12	18.0	2.8	12.0	500
QS-12	17.4	2.6	11.4	500
QS-15	20.8	2.6	14.80	500
QS-20	25.9	2.8	19.9	350

## • Material Lifts

Since the introduction of the original Genie® Hoist in 1966, Genie lightweight, low-cost material lifts — including the Genie Super Hoist™, Load Lifter™, Genie Lift™, Superlift Contractor®, Superlift Advantage® and Super Tower™ models — are designed to enhance worksite productivity with highly portable solutions for a wide variety of indoor and outdoor applications. Plus, a wide variety of options and accessories make them extremely adaptable to fit specific worksite needs.

MODEL	LIFTING HEIGHT	LIFTING CAPACITY
GL-4	4.2	500
GL-8	8.3	400
GL-10	9.1	350
GL-12	12.0	350
SLA-5	6.7	1000
SLA-10	11.6	1000
SLA-15	16.4	800
SLA-20	21.3	800
SLA-25	26.5	650
GH-3.8	12.6	300
GH-5.6	18.5	250



GH-3.8



SLA-20



GL-12

## • Boom & Scissor Accessories

Genie offers variety of accessories globally to maximize efficient use and increase, designed to make operators more efficient when working at height. For a complete list of accessories, please contact us.

### Genie® Lift Power™

The Genie Lift Power™ system includes a new generation of hydraulically driven generators for your customers, and their operators, who rely on productive power at the platform to get their work done. This contemporary accessory allows you to lift, drive and power tools, such as heavy-duty welders, for increased productivity.



### Genie® Operator Protective Structure (OPS)

The Genie OPS is an optional device for installation on an S or Z boom lift and provides secondary protection for operators in the event of contact with an overhead obstacle in certain applications. The Genie OPS features a tubular steel structure designed to transfer the kinetic energy into surrounding structures while maintaining a protected area for the operator. The device can be attached to boom lifts with 6 ft. to 8 ft. platforms and allows for excellent visibility. It weighs 36 lbs. and is bolted directly on the boom lift's platform; no modifications are needed.

## • Telehandlers

With outstanding design and performance, Genie® GTH™ telehandlers provide all-around utility to answer virtually all your work site needs. Available in six power-packed models, Genie telehandlers offer exactly what you need for productivity in limited-access areas or applications where high reach is needed. With a wide range of available attachments, Genie telehandlers can easily handle even the most demanding jobs.

Model	Max Lift Capacity	Max Lift Height	Max Forward Reach
GTH-5519	5500	18.1	11.3
GTH-636	6000	36.0	21.1
GTH-844	8000	43.1	28.2
GTH-1056	10000	56.1	42.0
GTH-1256	12000	56.0	42.0
GTH-1544	15000	44.0	27.3



**GTH-5519**



## • Attachments

Genie offers a wide selection of telehandler attachments for improved efficiency and added job flexibility. With the addition of Genie approved third party attachments, a single machine can handle even more tasks.



**Ind. Grapple Bucket**



**Buckets**



**Work Platform**



**Forks & Carriage  
48" / 60" / 72"**



**Heavy Duty Multi-Purpose Bucket**



## LEDWELL WATER TRUCKS

### • 2,000 Gallon Truck

As one of our top selling products, the Ledwell 2000 Gallon Water Tank lives up to its reputation. Excellent performance, durability and lifespan consistently make it a customer favorite. All our tanks are lined with an interior coating, an added feature that helps defend the water tank against deterioration. The 2000 Gallon Water Truck is painted to your color request and delivered with a quick turnaround.



LW2000WT

#### SPECS

- 2,000 Gallon tank capacity
- 350 gpm pump
- Protective interior coating
- 5 spray heads

#### FEATURES

- In-cab controls
- PTO driven pump
- Hose reel
- Top, hydrant, and reservoir filling capability

#### SAFETY

- DOT approved lights and reflectors
- Fire extinguisher
- Backup alarm
- Emergency reflectors
- Conspicuity tape

#### ADDITIONAL

- Stainless steel tank
- Water Cannon
- Sparger bar
- Legal load limiter component

### • 4,000 Gallon Truck

For your large-haul water projects, choose the Ledwell 4000 Gallon Water Tank. This truck is manufactured using high strength steel to ensure high-performance and efficiency and provide you with the exact service you need for your specialized job. All our tanks are lined with an interior coating, an added feature that helps defend the water tank against deterioration.

#### SPECS

- 4,000 Gallon tank capacity
- 350 gpm pump
- Protective interior coating
- 5 spray heads

#### FEATURES

- In-cab controls
- PTO driven pump
- Hose reel
- Top, hydrant, and reservoir filling capability

#### SAFETY

- DOT approved lights and reflectors
- Fire extinguisher
- Backup alarm
- Emergency reflectors
- Conspicuity tape

#### ADDITIONAL

- Stainless steel tank
- Water Cannon
- Sparger bar
- Legal load limiter component
- Hose reel with jet spray



LW4000WT



## BOX DUMP TRUCKS

Ledwell's Box Dump Trucks are a popular and efficient choice to transport loose material such as sand, gravel, or demolition debris.

Our Ledwell Box Dump Trucks are available for light, medium, or heavy-duty applications.

We offer multiple chassis and configurations to pair with dump truck beds, making this truck incredibly adaptable to a customer's unique material transportation needs.

### • 5/6 Yard Box Dump Trucks – Ford Chassis

The 5/6 Yard Box Dump Body will take care of your toughest loads. It is a popular choice for transporting loose material, such as sand, gravel or demolition debris. Ledwell Box Dumps are available for light, medium or heavy duty applications and can be paired with an in-stock chassis. We offer multiple chassis configurations to pair with any dump truck bed, making the Ledwell dump truck adaptable to any material moving need.

Specs	Features	Safety	Additional
<ul style="list-style-type: none"><li>• 5 to 6 cubic yard bed capacity</li><li>• 96" or 102" width</li><li>• 24" Side height</li><li>• Removable side boards</li><li>• Telescopic or Scissor hydraulic hoist</li></ul>	<ul style="list-style-type: none"><li>• In-cab controls</li><li>• Double acting tailgate with spreader chains</li><li>• Single chute in tailgate</li><li>• Spring loaded tarp cover</li><li>• 50 degree dump angle</li></ul>	<ul style="list-style-type: none"><li>• Safety support strut</li><li>• DOT approved lights and reflectors</li><li>• Fire extinguisher</li><li>• Backup alarm</li><li>• Emergency reflectors</li><li>• Conspicuity tape</li></ul>	<ul style="list-style-type: none"><li>• Air or Electrically operated tarp cover</li><li>• Double chute in tailgate</li><li>• Pintle hitch</li><li>• Multi-view camera system</li><li>• LED wrecker light bar</li></ul>



Dedicated to manufacturing quality equipment to make our customers' lives easier. Imagine what Ledwell can do for you.

Marden cutters are the top choice of experienced agriculturalists worldwide. At Marden, the extra time and money we spend on research and development results in a precision engineered piece of equipment – easy to operate with low maintenance and built tough enough to handle any job!

## • Brush And Weed Cutters

Marden has been the leader in developing a wide and diverse range of Brush Cutters (Choppers) for the last 70 years. We have many different models to choose from, and custom design for specific needs.



SHL7-30



M10



B10GK

## • Pasture Renovators

The Marden Pasture Renovators are designed for a variety of uses including clearing brush for ranching, enhancing wildlife habitat, renovating sod bound compacted pastures, and even establishing seed beds for over-seeding winter grasses. With the segmented spiraling blades these units give you a smooth even pull with operating speeds to 8mph. Models are available in Single Drum, Tandem Offset and even Triplex configurations.



SHPR12-42



HPR12-20



HPR12-30B

## • Forestry Implements

We have several product lines available in the Forestry Implements category. Including Bedding and Subsoil Plows, Versa-Till, Drum Choppers, V-Shears & Blades, Fire Plows and the Marden Pruner. Please contact us for a complete list and details of all Marden Forestry Implements.



Bedding Plows



V-Shears & V-Blades



The Marden Pruner



Versa-Till Plows





MASSEY FERGUSON

## AGRICULTURAL TRACTORS

Unlike most single-brand manufacturers, who attempt to develop their own equipment across a range of categories and applications, we've built a portfolio of best-in-class brands, each delivering expertise in its own unique field. Constantly sharing the kinds of insight and technology that drive continuous innovation and help farmers succeed. Each one-off our storied brands provides technologies that help farmers maximize yield, reduce loss and conserve the resources that are so important to meeting the world's growing need for food, fuel and fiber.

- **GC1700 Sub-Compact Tractors**

You worked hard for your special piece of land. You continue to put everything you can into it, because that's the way you do things. That's why we built the Massey Ferguson® GC1700 Series tractors. For more than 170 years, we've made tractors for people like you—tractors that are strong and versatile, built to handle a wide variety of conditions and applications. On your land, there's always something to be tended to, even when everything is perfect.



- **MF1526 Compact Tractor**

You wanted a small tractor with more application versatility. That's why we've brought back the Massey Ferguson® 1526 premium compact tractor. Built especially for a new generation of landowners and hobby farmers who want a tractor that's as hard-working and practical as they are.





MASSEY FERGUSON

## UTILITY TRACTORS

- **2600H Series**

A line of utility tractors that are as tough and dependable as our classic Massey Ferguson models. The Massey Ferguson 2600H Series is a rugged line of tough and dependable utility tractors that brings back the heritage and affordability of classic Massey Ferguson models. Yet these tractors still feature everything you expect in a Massey Ferguson, starting with a simple, open design.



- **2800E Series**

The versatile Massey Ferguson® 2800E Series combines the practicality of a compact tractor with the bigger functionality of a utility tractor. It's crafted for a new generation of rural lifestyle customers. Hobby farmers. Farm-to-table. Small businesses. Or just people with a lot of property and a lot of jobs to wrangle. Like them, these are hard-working, no-nonsense, roll-up-your-sleeves tractors.

- **4700 Series**

The 4700 Series is built for tough, gritty jobs. It's also built to be easy to use and comfortable to operate. From the ground up, these tractors are engineered for smart, ergonomic, long-lasting operation. Because even though the work is tough, your tractor should never be hard on you.





MASSEY FERGUSON

- **MF5700 Mid-Range Tractors**

The Massey Ferguson® 5700 Series has been tested in farming applications around the world to meet a wide set of demands. These tractors are uniquely designed for more power to pull heavier implements while still being nimble enough to maneuver almost anywhere. You get the versatility and ease of use you need to feel right at home during a long day's work.



- **MF6700 Mid-Range Tractors**

Massey Ferguson® 6700 Global Series tractors are unlike any mid-range we've ever built. They were engineered from the ground up, then tested in the harshest conditions around the world, for more powerful, versatile, long-lasting operation.

These machines are purpose-built to provide unmatched lift capacity and the power to pull heavier implements through the toughest jobs, with the next-level comfort of our deluxe cab and features.





MASSEY FERGUSON

- **MF7700S Series**

The Massey Ferguson® 7700 S Series tractors have been designed and built to meet the needs of professional farmers across all sectors.

A comprehensive choice of power output, transmission, cab specification, hydraulics and PTO variants means individual customers can specify a machine that precisely meets their every need.



- **MF8700S Series**

We've put over a century and a half of farming innovation into each tractor we make, and we've engineered the Massey Ferguson® 8700 S Series to provide the performance and versatility to tackle any job you throw at it. Whether it's row crop or dairy operations, planting, mowing or hauling, the MF 8700 S Series won't quit until you do. If you need to get the job done right, this is your tractor.



Driving a Fendt is more than just driving a tractor. It comes with a feeling of ease, even during the toughest work. Because, thanks to the continuously variable Fendt Vario transmission, there are no gear steps, but plenty of performance – from the smallest narrow track tractor or vineyard tractor up to the high-horsepower tractors, from the Fendt 300 Vario to the Fendt 1100 Vario MT. Ever since the Dieselross, Fendt tractors have been setting standards in efficiency and driving pleasure for agricultural machinery. Whether it is a used tractor or a brand-new tractor – the unique Fendt driving sensation is convincing.

- **Fendt 1100 Vario MT**

The Fendt 1100 Vario MT not only touts the highest horsepower in the industry but is the only track tractor of this size to feature our revolutionary Vario CVT transmission.

If you weren't already good at what you do, you probably wouldn't be looking at a Fendt tractor to begin with. Fendt's long-time reputation for uncompromising excellence is further enhanced by the 1100 Vario MT.



- **Fendt 1100 Vario**

With models ranging from 396 to 517 horsepower, a base/max weight of 38,000 – 52,000 lbs., all powered by our VarioDrive CVT transmission, the Fendt 1000 series accomplishes more than any other tractor you'll find.

The Fendt 1000 Vario harnesses its power. Its large tires, intelligent ballasting and tire pressure assistant as well as unique, variable four-wheel drive deliver the right amount of grip in any situation – along with outstanding maneuverability. And it has more than just pulling power.



- **Fendt 900 Vario MT**

The soil forms the basis of healthy crops and high yields. Managing it efficiently and with care ensures long-term economic success. In addition to efficiency and comfort, soil protection is our top priority when developing tractors. Love your land, farm with Fendt.

The Fendt 900 Vario MT combines the best of two worlds. The experience gained from installing more than 250,000 Vario gearboxes, and more than 30 years of working with track tractors, as well as the Fendt operator environment and Fendt Smart Farming functions make this a modern and innovative track tractor.

Machine power alone is no longer sufficient for efficient cultivation of large areas. Enormous potential lies in planning and documentation of work, and automatic control of partial widths and seed rates. Fendt Smart Farming offers you the functions and interfaces you need.



- **Fendt 900 Vario**

If you're a large-scale farm or contracting operation, you're serious about agribusiness. And you're

serious about your equipment, because you know the difference between break-even and profitable is defined in hours, gallons and data.

The high-performance Fendt 900 Gen 6 Series is purpose-built to be the hardest-working, most reliable tractor you can buy. Sure, others talk about efficiency, productivity, fuel-savings, comfort and profitability. But no one is more obsessed than Fendt with engineering them into every tractor we make.



- **Fendt 800 Vario**

The Fendt 800 Vario is the popular high-horsepower tractor that scores high in compactness, flexibility and performance. With up to 287 hp, they are not only powerful in the field, but also superior for transport work. It is also superior down to the last detail, with smart and efficiency-enhancing technologies, such as the tire pressure regulation system VarioGrip, automated steering and much more.

The benefits of optimum tire pressure are clear: According to neutral tests, the ideal tire pressure saves up to 8% fuel and increases area coverage by up to 8%.\* Tractive power can also be increased by up to 10%.\* Furthermore, it reduces soil compaction and therefore keeps yield losses at a minimum. When driving on the road, a higher air pressure ensures more stable handling and lowers roll resistance, which reduces fuel consumption and tire wear.



- **Fendt 700 Vario**

This versatile tractor, ranging from 144-237 hp, is your perfect partner for all kinds of work – from easy-going grassland work, to dynamic transport, to heavy-duty field or fleet operations. It's the cornerstone behind every Fendt innovation: take something great and make it better.



The curved windscreen of the VisioPlus cab offers a 77° viewing angle.

## • Fendt 500 Vario

The Fendt 500 Vario is the perfect all-round tractor that you can always depend on. With its incredible power to weight ratio this tractor is a nimble, powerful tractor that is ideally suited for loader applications, light tillage work, baling and hay production and transport operations. Fendt 500 Vario. The perfect fit for your operation.

The Fendt 500 has the high-power ratings, flexibility, quality and efficiency to meet the demands of your farm. Whether it is a large cattle or dairy operation, mid-sized grain farm, or hay production that defines your operation the Fendt 500 has the ability to adapt to meet the needs of your farm to increase the bottom line. Make your farm future-proof, with the Fendt 500 Vario, the tractor for all seasons.



## • Fendt 300 Vario

The Fendt 300 has been a unique success story since 1980, with 140,000 vehicles sold. This series is perfect for most farms in terms of performance, quality, versatility and outstanding residual value. The 4th generation Vario features the all-new driver's workstation with FendtONE as well as the high-end model 314 with 152 hp max. output. The concept seamlessly unites machine and office. With this, the 300 is again a pioneer among compact standard tractors.

Soil compaction reduces yield, and that's true for arable farming and grassland. Extensive tire options and the low weight-power ratio of the 300 are gentle on your soil. At just 5010 kg or 33kg/hp, the 314 is lightweight and can ballasted to your needs.



Fendt 314Vario, 33kg/hp

Competitor 1, 43kg/hp

Competitor 2, 47kg/hp





## • Fendt Rogator 900

Introducing the industry's only rear boom sprayer with two-height adjustable clearance. Elevate your operation with the Fendt Rogator® 900 Series.

With a common chassis and interchangeable systems, the Fendt Rogator® 900 Series sprayer can handle a wide variety of terrain and crops with ease. The RG934H and RG937H also offer the ability to perform high-clearance applications for late-season work with the Elevation package.

### Versatility:

- Go from standard-clearance to high-clearance application in less than 45 seconds.
- Change from liquid to dry application in under two hours for unmatched ROI optimization.

### Control:

- Integrated and intuitive Fendt Varioterminal™ gives you full machine control
- AWD SmartDrive™ continuously and independently powers each wheel for superior traction

### Suspension:

Four-corner airbag suspension and patented dual struts allow for 6 inches of vertical travel. The ride for the boom and operator results in greater stability and control, both on the road and in the field. Rough terrain has met its match. Rogator's proven Flex Frame ensures tire contact with the ground for ultimate traction.



## AirMax® Precision R1/R2 for the ultimate in accuracy.



FENDT® ROGATOR® 900 SERIES | 315 TO 365 HP  
GROW BOLD.

## ROGATOR C SERIES | RG900C | RG1100C | RG1300C

With the world's most advanced liquid-system technology, the RoGator® C Series sprayer from Challenger is changing the game in professional-grade application. Its exclusive LiquidLogic® system doesn't just improve precision — it also minimizes product waste and risk of contamination for your crop. Its longer, lighter aluminum booms in 120- and 132-ft. options cover up to 32% more ground at the same time as a standard 100-ft. boom.

Agricultural Sprayers



**EVERYTHING ABOUT THIS MACHINE IS DESIGNED TO DELIVER MORE PRECISE APPLICATION.**

MODEL	HP	SYSTEM	BOOM WIDTH
RG700	165	Liquid Only	60/80 or 60/90
RG900C	280	Liquid/Dry Spreader	90/100/120 std.   120/132 aluminum
RG1100C	315	Liquid/Dry Spreader	90/100/120 std.   120/132 aluminum
RG1300C	339	Liquid/Dry Spreader	90/100/120 std.   120/132 aluminum

### TERRAGATOR C SERIES | TG7300C | TG8300C | TG8400C | TG9300C

In 1973, the TerraGator® 1253 became the first self-propelled, three-wheel applicator with high-flotation tires in the industry. Today, TerraGator continues to be the industry leader in three- and four-wheel high-flotation applicators. Each model features a rugged chassis that delivers unmatched performance and durability, while an AGCO CVT, coupled with an electronically controlled AGCO Power™ diesel engine, delivers power where you need it in a highly responsive, fuel-efficient platform. In fact, each TerraGator model produces peak torque to the ground at engine speeds as low as 1,500 RPM, while consistently maintaining that torque.

Agricultural Floaters



THE ULTIMATE IN CROP CARE PRECISION AND PRODUCTIVITY.

MODEL	HP	SYSTEM	WHEELS
TG7300C	332	Liquid/Spreader/AMP 1 & 2/Air Spreader	3
TG8300C	365	Liquid/Spreader/AMP 1 & 2/Air Spreader	3
TG8400C	365	Liquid/Spreader/AMP 1 & 2/Air Spreader	4
TG9300C	425	Liquid/Spreader/AMP 1 & 2/Air Spreader	3

Since 1946, Woods has grown to become the undisputed mowing expert. This legacy began with development of the first tractor-mounted rotary cutter and continues today with unmatched product innovation and service. No matter if you're cutting brush or mowing pastures, Woods has the rotary cutter to fit your needs. Woods rotary cutters – dedicated to craftsmanship and innovation for more than 60 years.

## • Bat Wing Cutters

Over 50 years ago, Woods® introduced the original flexwing rotary cutter, the Batwing®. It instantly became a household name for flexwing cutters. Why? Because you needed a rugged piece of equipment that could tackle the toughest rural mowing jobs...and the Batwing delivered.

You told us what you wanted in a rotary cutter, and we delivered. It's more reliable, more durable, easier to use, easier to maintain and built to perform better.

A variety of Woods-exclusive features make it outstanding in its field.



**BW15.60**



**BB720X**

## • Single Spindle Cutters

Woods BrushBull™ single-spindle line has set the standard for today's rotary cutter market with innovations such as the smooth, slope-top deck and quick-change blades.

Put our products to the test in your own back yard. Rugged, dependable and productive Woods rotary cutters are designed and tested for the extremes of real world use.

## • Multi Spindle Cutters

This heavy-duty rotary cutter is versatile, rugged, and built to handle a host of applications. A solid and all-around performer, this triple-spindle cutter is well suited for orchard, commercial, and agricultural use such as crop shredding.

The proven leader in the cutter business delivers a full line of durable easy-to-use rotary cutters. Choose our classic belt-driven model or a 30-, 40-, 50- or 60-series model loaded with features that help you work efficiently and effectively – whatever you're cutting or shredding.



**MDS10.50**

## • Finish Mowers

For those who demand a professionally groomed lawn, Woods high-performance finish mowers ensure a clean, crisp, manicured appearance year after year. Our unique rounded front, tapered-side rear discharge deck allows you to mow with better maneuverability – reducing trim time and increasing productivity. Heat-treated, alloy steel blades provide maximum performance and precision cutting for all your lawn care applications. The combination of a deep deck, baffling and unique rear discharge design ensures premium results – making Woods synonymous with “cut quality.”

You'll look forward to using and maintaining your equipment with many features that focus on your drive for a high-quality cut in record time.



RD72



BSS72

## • Box Scrapers

Often imitated, but never duplicated, Woods offers a full line of rugged, high-quality attachments with innovative features that increase productivity, maximize performance, and minimize down time – whether they're needed for commercial use or general lawn care projects.

Over 55 years of experience engineering and manufacturing landscape equipment has created a line of reliable, high-quality tools to meet, and exceed, the demands of our customers from professional landscapers to property owners. Trust Woods for all your landscaping needs.

## • Post Hole Diggers

We build a full line of tools to tackle a variety of projects that shape, create and maintain your land. We'll help you get the most out of the investment you've made in your tractor. And, at the end of the day, we'll help you feel good about all the chores you checked off your list.

- Standard shear pin protected shaft extends service life.
- Options include parking stand, auger extension, semi-double and double flight augers, and hydraulic down force kit.



TPD95

Hall Manufacturing has been producing hard-working, heavy-duty brush cutters and brush hogs in the USA for more than four decades. We pride ourselves on engineering and manufacturing only the most reliable, durable, and competitively priced brush cutters on the market. Bush-Whacker mowers have been the choice of the Department of Transportation for more than 40 years and our heavy-duty brush cutters are the choice of today's farmer.

- **ST-120 - 10' Heavy Duty Flex-Wing Brush Cutter**

A close relative to the ever-popular ST-180, the ST-120's smooth-top design is one of the most rugged flex-wing brush cutters on the market today. With its 4" cutting capacity and 250 HP gearbox, you will be hard-pressed to find another mower that can outperform the ST-120 in the field or at the cash register.



- **ST-180 - 15' Heavy Duty Flex-Wing Brush Cutter**

ST-180 Elite raises the bar for flex-wing brush cutters on the market. Built off the time-tested T-180, the ST-180 has a smooth top deck for ease of cleaning. The ST-180 will show up to work every day and will tackle the toughest mowing challenges. The ST-180 will show up to work every day and will tackle the toughest mowing challenges.



**Wing Drive Shaft CAT 4**

- **ST-240 – 20' Heavy Duty Flex-Wing Brush Cutter**

Bush-Whacker's 20-foot Flex Wing Brush Cutter allows for more acreage cut per hour – a truly efficient machine for large jobs. Dependable and capable of cutting anything 4" and under.

Bush-Whacker's 20-foot Flex Wing Brush Cutters allow for more acreage cut per hour – a truly efficient rotary mower for large jobs.



- **MD-144 / 12' Med. Duty Flex-Wing Brush Cutter**



The MD-144 is a Dual-Spindle Flex-Wing unit is perfect for tractors running with 35 to 75 HP.

So, whether you are the “weekend farmer” with 10-40 acres who are looking to reduce his cutting time on the weekends or the professional mowing pastures, we’re certain you’ll find the MD-144 has what it takes to get the job done!

You’ll be amazed at how Bush-Whacker has provided such Big-time features in this smaller-sized brush cutter.

- **MD-180 / 15' Med. Duty Flex-Wing Brush Cutter**

This easy to clean flex-wing brush cutter is one of the sturdiest medium duty cutters on the market today. It comes with a smooth-top design at a great price and is perfect for mowing grass and weeds up to 3" in diameter. With deck-rings included as standard equipment, the MD-180 is a great bargain.

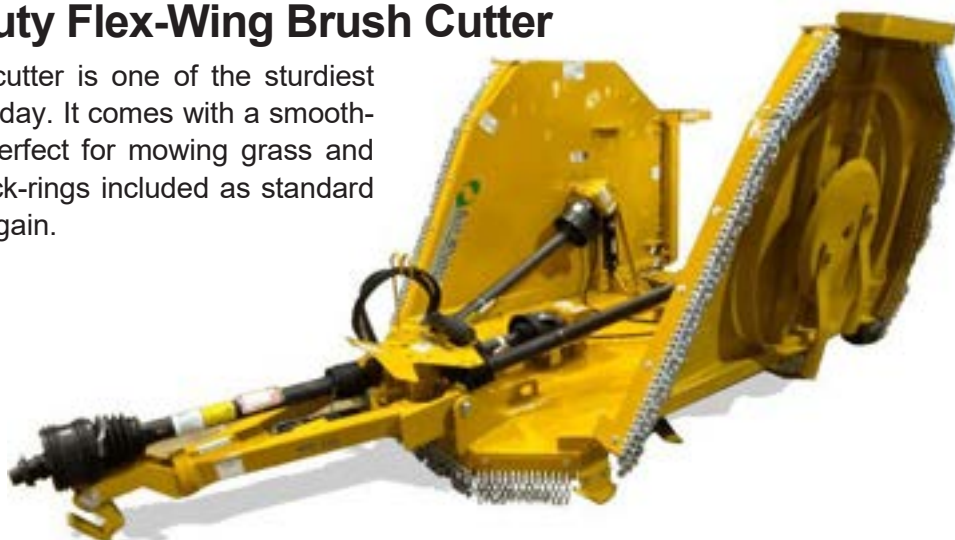

- **ST-104 Dual Spindle Heavy Duty Brush Cutter**



This 8-foot dual spindle brush cutter has a double-deck smooth top design that is the perfect unit for the farmer or right-of-way cutting contractor. Considered by many to be one of the best economically smart buys on the market today!

Bush-Whacker’s Dual Spindle Series of brush cutters give you a great cut at a great value.





- **HD-121P –Heavy Duty 10’Smooth Top Rotary**



With two-spindle gearboxes, 250 HP, and longer blades, these rugged, heavy-duty 10-foot brush cutters can handle any job you throw at them. And the smooth-top deck makes them easier to clean.

Bush-Whacker mowers are increasing in demand for agricultural, commercial, and other applications where a heavy-duty, rugged mower is needed. Bush-Whackers are available in a range of sizes to fit your needs -from the five-foot model all the way to the 20-foot model.

- **HD-60 / 72 / 84 – Single Spindle Heavy Duty Brush Cutters**

Bush-Whacker’s Single Spindle Series of brush cutters give you a great cut at a great value.

Bush-Whacker’s heavy duty single-spindle cutters are great for small areas of grass and small brush. It’s truly a great cut for your money.

The Bush-Whacker units come standard with stump-jumpers and deck-rings, and when combined with 120HP gear boxes, you will be hard pressed to find a better value on the market today.



- **High Performance Single Spindle Brush Cutters**



Duly named high-performance because these units are the most durable cutters in their class. Over the years they have become the staple of roadside & government mowing because of their exceptional performance and reliability.

Featuring a dual-deck smooth top and a massive 250 HP gear box, these brush cutters are ready to cut brush up to 4’ in diameter. This may very well may be the last cutter you will ever purchase.



- **SSM-72 Bush Cutter Skid Steer Mower Attachment**

The Bush-Whacker Skid Steer Mower Attachment is a 6-foot skid steer mounted brush mower that can take on the toughest jobs and is durable enough to clear cut standing trees up to 8 inches in diameter. These mower attachments are perfect for your brush hog.

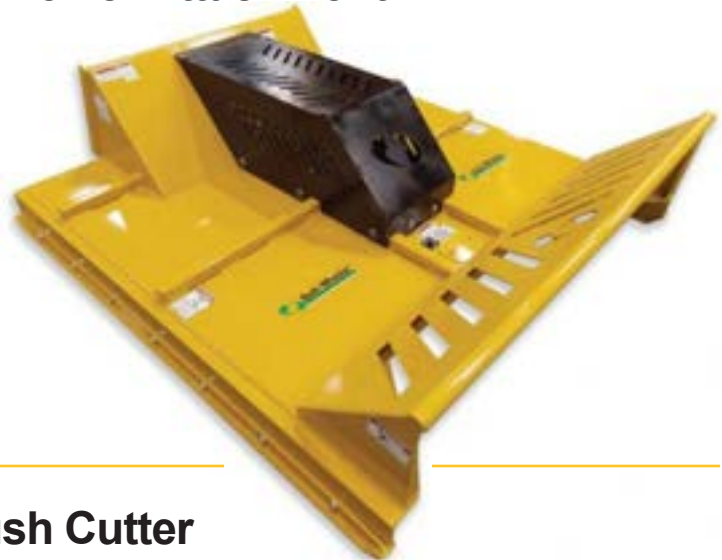

- **RME-22 Rear Mount Boom Brush Cutter**

Bush-Whacker's Boom Cutters are a rare breed, but essential for certain challenging jobs. These rear-mounted units can maneuver into those hard to reach areas. With 108° range of motion, these cutters are ideal for trimming trees and high brush, or ditch banks and ponds. 22-Foot Rear-Mount Boom Mower. The cutting edge of versatility with all the quality, service, and dependability you've come to expect from a Bush-Whacker. Five-foot brush cutter with a 22-foot boom arm. With advanced joystick controls of four axis of motion. Independent, pressure compensated hydraulic system with load sensing capabilities. A 7" gauge deck with 3/8" side skirts. High-strength steel tubing on primary and dipper booms.

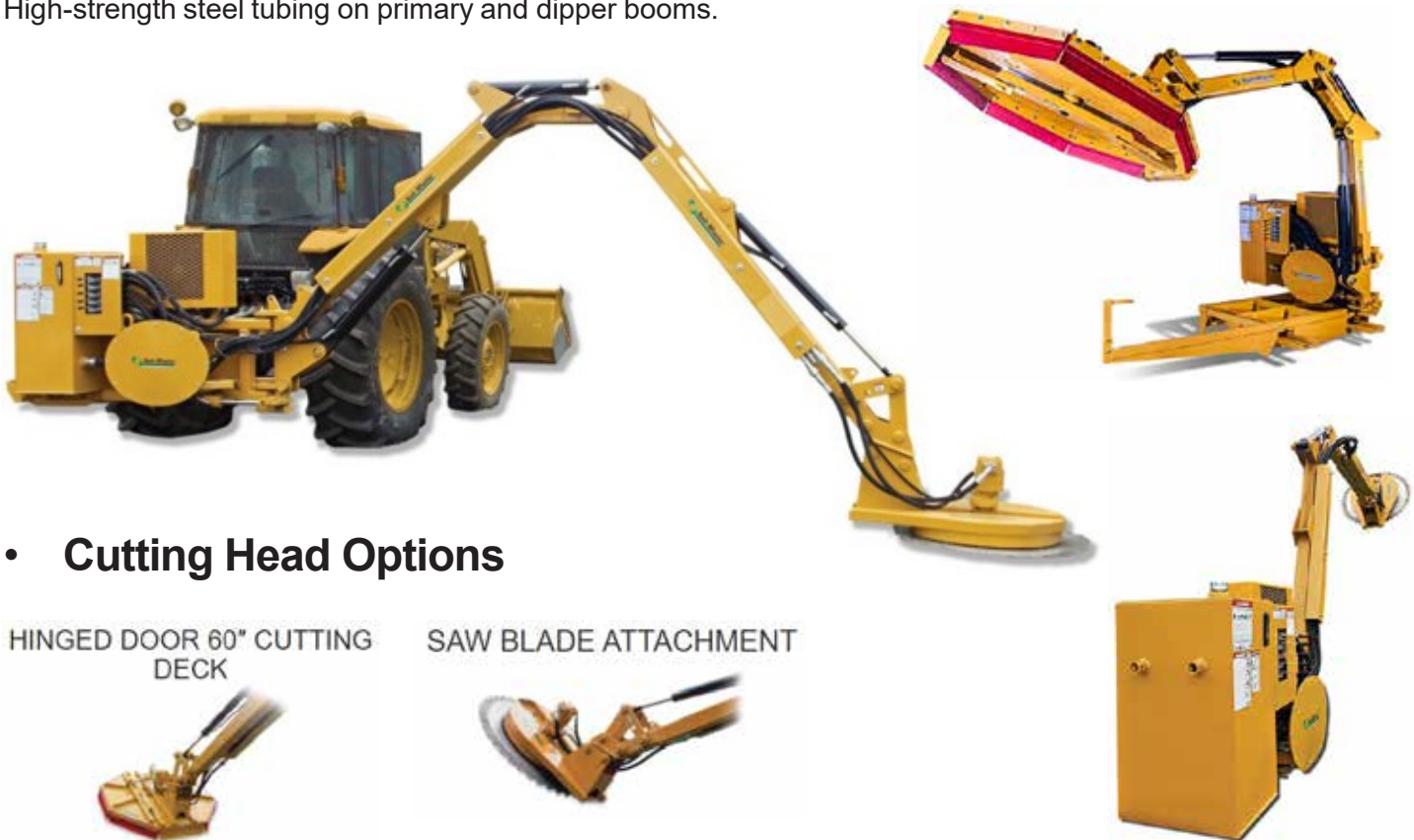

- **Cutting Head Options**

HINGED DOOR 60" CUTTING DECK



SAW BLADE ATTACHMENT





At Diamond Mowers, we build the best. Our heavy-duty equipment is the toughest, safest, and most reliable in the business.

## • Boom Flail Mowers



## • Hydraulic Coolers



- Cooling**  
Virtually impossible to overheat
- Comes Standard**  
Comes standard on all Diamond boom mower products
- Pump & Grill Guard**  
Mounted to a pump & grill guard
- Auxiliary Light**  
Auxiliary Light comes standard for enhanced visibility

## • Boom Rotary Mowers

Available in 50" & 60" cutting widths

Cuts up to 4" material continuously and 8" intermittently

Oil bath spindle 260% stronger than greaseable spindle

Proprietary Tri-Hex disk provides greater inertia in tough conditions

Hydraulic Trap Door

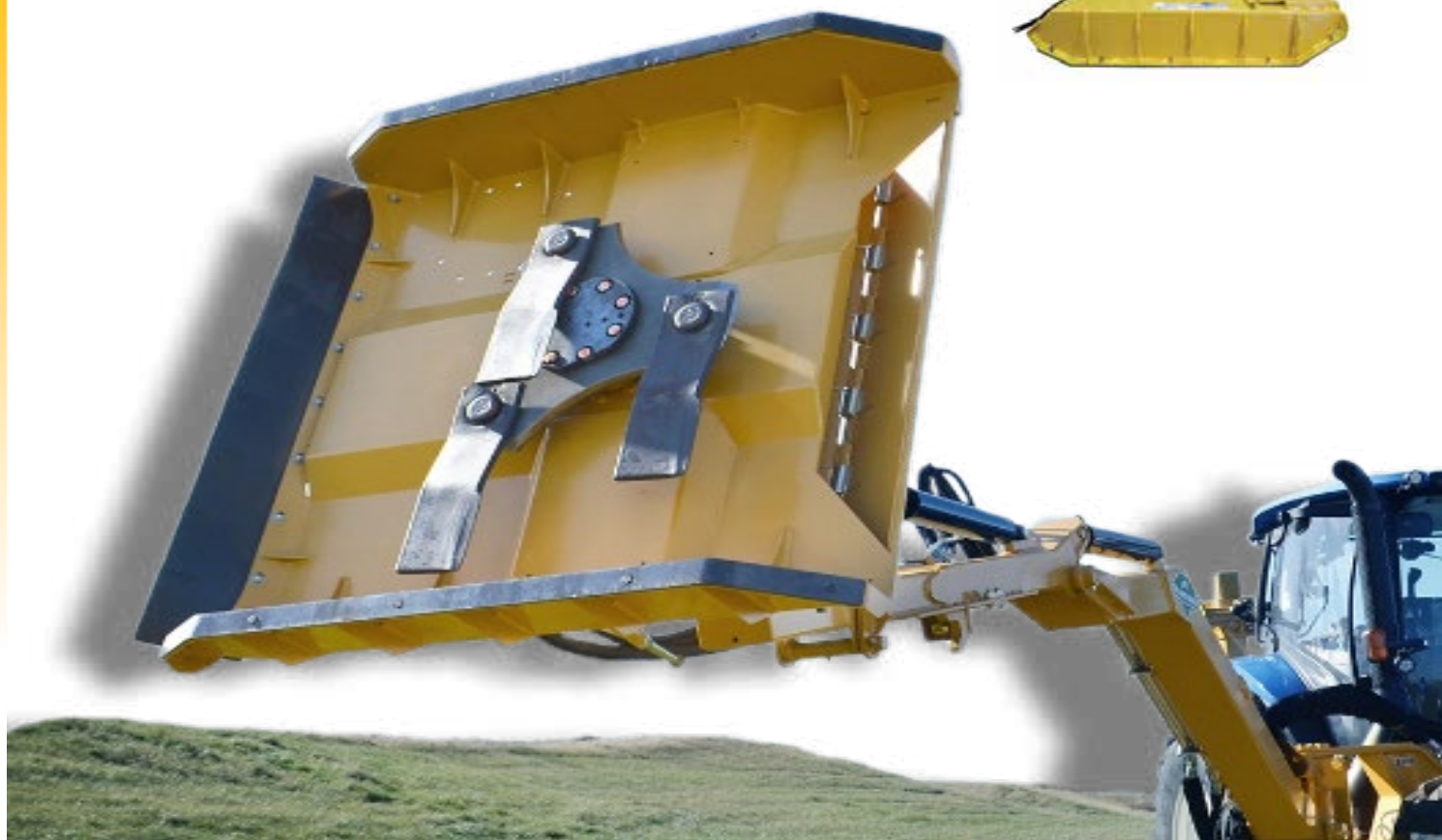



- **Booms**

At Diamond Mowers, we believe that no task should be beyond your grasp. Our Boom Mowers are available in a variety of lengths and cutting heads, so whether you're dealing with ditches, guardrails, fences, or a tricky slope, we've got you covered. For decades, Diamond has manufactured the toughest, smartest, most reliable and safest equipment in the industry. And we back it up with unmatched customer support, a 72-hour parts guarantee, and a 30-day satisfaction guarantee.



- **Rear Cradle Boom**



- **Side Fold Boom**



Rome Plow was founded in 1932, by Tom Mullen and his partner, Jack Lemann. Mr. Mullen, the Caterpillar dealer for Honduras in Central America, found a need for high quality tillage implements to be used in conjunction with Caterpillar tractors. To satisfy this need, Lemann and Mullen purchased the Towers and Sullivan Plow Company of Rome, Georgia. Towers and Sullivan Plow Company was established in 1877, and already had a strong name in the implement industry. The company was moved from Rome to Cedartown in 1934, where it has continually expanded its facilities and product line. The original charter of manufacturing auxiliary equipment for Caterpillar prime movers and marketing them worldwide through the Caterpillar dealer network has been maintained.

For a complete line of Rome Equipment, please contact us at (239) 693-6363

### • Wheel Offset Disk Harrow

#### FEATURES:

- Heavy duty proven design with rugged boxed angle construction welded for maximum strength and rigidity.
- High gang carrier design to prevent trash build up and clogging.
- Levels, cuts, and mixes to full working depth.
- Combines ease of maneuverability with high strength for the most adverse conditions.
- Up to 178lbs (81kg) of weight per disk blade depending on model with an average of 171lbs (78kg).
- Up to 8" (203mm) maximum depth of penetration with standard 24" (610mm) diameter disk blades.
- Equipped with Timken dual tapered roller bearings.
- Adjustable disk blade scrapers.
- Dual purpose transport unit for transportability and penetration control.





## IRRIGATION

### • Micro Series Hose Reels

The ABI Micro Series Irrigation Travelers are ideally suited for sports fields, landscape areas, horse arenas and small acreage farms requiring irrigation at an affordable cost. Offering a dependable and economical solution with simple operation and minimal labor requirements. Conventional portable systems, while being an excellent alternative to in-ground installation. Micros operate unattended and are fitted with automatic shut-off valves as a standard feature.

#### Standard Features:

- Low pressure turbine with maintenance free gearbox.
- Minimum Pressure requirement of 73 PSI. (Max. 134)
- Automatic drive shut off valve at end of irrigation.
- Automatic water shut off valve.
- Adjustable width wheeled cart.
- Part circle sprinkler with 2 nozzles.
- Glycerin filled pressure gauge
- Scroll type hose-guide for even wind up of hose.
- Speed control valve for accurate application rates.
- Extra wide floatation tires.
- 12 foot supply hose with quick couplers.
- Automatic cart loading and lifting.
- Rotating third wheel.
- Lockable drive system cover



### • GX Series Hose Reels

The GX series of travelers provide economical irrigation using an efficient, accurate and patented turbine drive system with a low-pressure requirement. The simple drive system features an integral gearbox and turbine assembly directly driving the reel with accurate speed compensation and achieving the high speeds required for light application of water to delicate crops.

The GX series professional hose reel irrigators provide economical irrigation from 3 to 13 acres per pull.



#### Standard Features:

- Low pressure turbine with maintenance free gearbox.
- Minimum Pressure requirement of 68 PSI. (Max. 140)
- Minimum Flow requirement of 45 gpm. (Max. 148)
- Adjustable width wheeled cart.
- Part circle sprinkler with 2 nozzles.
- Pressure gauge
- Scroll type hose guide for even wind up of hose.
- Speed control valve for accurate application rates.
- 12-foot supply hose with quick couplers.
- Automatic cart loading.

The Leader in  
Hose Reel Irrigation!



# ABI

irrigation

## • JX Series Hose Reels

The JX series travelers provide the operator with simple set-up and operation with fingertip hydraulic controls. The standard hydraulics operate the jack, wheels, stabilizer legs, making large scale irrigation an easy low-labor operation. As the wheels lift, the machine is lowered gently on the ground giving additional stability and enabling the wheeled cart to load and lift itself automatically into the transport position at the end of the irrigation cycle. The simple drive system combines a 4-speed gearbox and turbine assembly ensuring accurate speed retraction with high efficiency and low-pressure requirement.



## • Irrigation Booms

ABI low-pressure fully galvanized irrigation booms are ideal for situations where high wind conditions are a problem or where extremely light applications are required for seedbeds and delicate crops.

They can also be used for wastewater applications applying the liquid close to the ground and eliminating wind-drift and odor problems. Saving energy and giving excellent uniformity. The light spray application eliminates compaction of heavy soils making more use of fertilizers and reducing "run-off" damage.

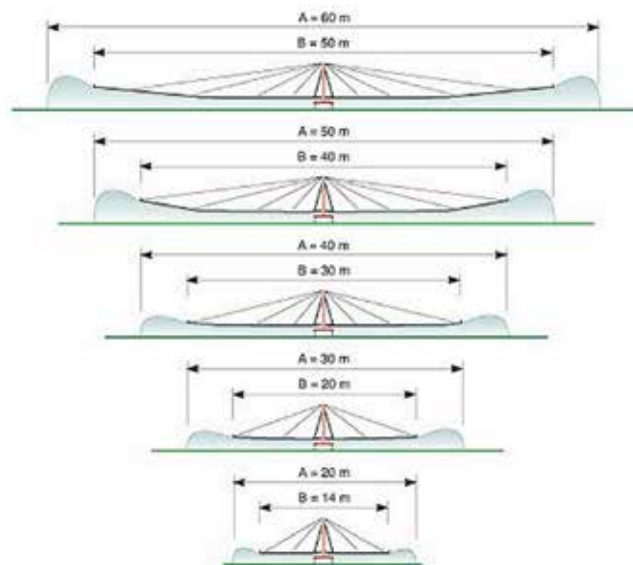

## Perfect Balance Of Engineered Toughness & Intelligent Design

Since 1962, Degelman Industries has pioneered the perfect balance of engineered toughness and intelligent design. The result is outstanding equipment that exceeds expectations and outperforms. We achieve this through meticulous design and vigilant customer service.

Every day, the designers in our state-of-the-art research and development facility work tirelessly to provide new and innovative solutions to fit the ever-growing need of performance, quality and durability for today's agricultural and industrial equipment. And our Customer Service Centre's goal is to make sure customers are taken care of no matter how long ago our equipment was bought. Because if it has our name on it, we expect nothing short of optimal performance.

### • Tillage

#### The fastest and most versatile piece of tillage equipment you will ever own

Pro-Till® now comes in 14,17, 20, 26, 33, and 40 foot models to fit your operation. Designed to shred heavy fall residue, open up spring fields, level ruts, destroy clods and produce an absolutely perfect seed bed. Pro-Till® is your single tool for tillage.



#### Maximum Trash Flow

The disks have a shallow face to eliminate compaction layers and the high tensile strength steel arms provide maximum flow through with three times the spring back of normal mild steel.



#### Improved Roller Trash Flow

With fewer angles and a larger span between the roller and frame Pro-Till 20/26 allows ample room for trash to exit in between.



### • Heavy Harrows

**More Than A Big Harrow.** In today's farming, time is precious. We have big acres to cover, with a relatively short growing season. Our leading farmers have been waiting for a tool to help warm the soil and promote effective seed germination. The Strawmaster Pro, with its incredible tine penetration, not only rakes straw, but moves ground, blackening up the field, stimulating plant growth when it's most critical.



- Tungsten Carbide.
- Consistent Field Finish.
- Enhanced Control.
- Best Overall Value.



## • Landrollers

Degelman landrollers not only decrease downtime and fuel costs, they also provide optimal seed to soil contact while reducing moisture loss. Level land, free from protruding rocks, allows cutter bars to safely access the base of plants without the risk of rock ingestion. This allows for a faster, safer and easier harvest which ultimately translates to an increased yield on pulse crops such as beans and cereals.



Landroller LRX



Five Plex Landroller



Tri-Plex Landroller



Single Drum Landroller

## • Rock Removal

**The King is Here!** Degelman introduces its largest rock picker ever. With an incredible 8' wide grate, 5 cubic yard bucket and 7'3" dump height, the Degelman Rock King is simply second to none.

The Degelman Rock King is the culmination of more than 55 years of pursuing excellence. Degelman rock pickers are unrivaled for performance and durability and are THE industry standard. Our attention to detail means these machines will work flawlessly for years to come, as you will commonly find Degelman rock pickers made 55 years ago still working today.





## • Dozer Blades

They are tough. We have manufactured literally thousands of these blades, and most are still pushing. If you want a proven blade for your high-horsepower, 4WD tractor, this is where your search ends. We have an arsenal of tilt, lift and hydraulic or manual angle options available, so you can choose what's best for the jobs you do every day.

Regardless of what you select, each of these blades are backed by the Degelman quality standards we set for all our blades—from our industrial-strength cylinders that we manufacture ourselves... to the double-skin construction of the blades for extra toughness. Whatever choice you make, it's a clear quality winner.



3500  
40-150HP



4600/5700  
65-380 HP



5900  
125-500 HP



66/69/7200  
200-500 HP



7900  
300-700 HP

## • Manure Spreader

Degelman Tough.

How do you build the best manure spreader in the world? Start with Degelman, renowned for building legendary equipment for the past 55 years. The design is unmistakably Degelman. The most rugged spreaders available - the Degelman M Series.

From the ground up, these machines have been designed with rocks in mind, from its proprietary retractable free-swing flails, super duty gearbox, smooth sidewalls and heavy-duty frame to its clean gate opening.



### Walking Beam Suspension

Degelman manure spreaders incorporate a straightforward and time-tested walking beam floating suspension system. Tandem walking wheels cut uneven terrain in half with a massive unrestricted range of motion. All four wheels are always in contact with the ground surface. Coupled with a wide stance, these machines will ride over the roughest terrain with ease and control.





## LOWBOY TRAILERS

Haul a wide range of construction equipment with Etnyre's Blackhawk® trailers. From removable goosenecks to spread axles, we customize each unit to suit your specific requirements for safe and effective transportation.

- **Hydraulic Removable Gooseneck**

Etnyre's Blackhawk® removable gooseneck trailer series offers a variety of trailer capacities, ranging from 25- to 85-tons, to best accommodate your load.



### FEATURES

- 35- to 60-ton standard capacities for hauling a variety of equipment
- Tandems, tridems and spread axle options available for optimal weight distribution
- High-quality, two-part urethane paint ensures lasting, durable finish that stands up to road salt and resists scratches for higher resale value
- Adjustable deck height, high lift gooseneck and road clearance for optimal flexibility and safe traveling
- 102-inch wide by 22- to 26-foot long decks provide ample room for equipment  
Custom built models up to 125 tons



- **Mechanical Removable Gooseneck**

Etnyre's heavy-duty Blackhawk® mechanical removable gooseneck trailers offer 25- to 55-tons of capacity for safe and dependable equipment transportation. Every unit is engineered for optimal durability and custom-built to suit your applications.



### FEATURES

- 25 and 55-ton models
- Mechanical gooseneck with customizable fifth wheel height
- 29-foot long decks provide ample room for equipment
- Adjustable for compatibility with a variety of trucks
- Sloped front ramp for easier loading and unloading





## • Paver Special

Etnyre's Blackhawk® Paver series trailers offers 35-, 50-, 55- & 70-ton models to best accommodate your load.

Transport your roller, paver and broom in one load with Etnyre's Blackhawk® Paver series trailers. They offer 24 feet of deck space and a low loading angle of just 18 degrees for fast and easy loading and unloading of equipment.



## FEATURES

### Hydraulic Removable Gooseneck Paver Special

- 35- & 50-ton models to accommodate most broom, paver and roller models
- Adjustable width front ramps and full-width rear deck allow for easy loading and unloading of a variety of equipment
- Adjustable and removable gooseneck for compatibility with a wide range of trucks
- 102-inch wide by 22-foot long deck provides ample room for equipment
- Adjustable deck height and road clearance for optimal flexibility and safe traveling
- 50- & 70-ton models to accommodate most broom, paver and roller models
- Variable deck height and road clearance for optimal flexibility and safe traveling
- Fast and easy hydraulically operated 8-foot bi-fold ramps
- Manual exhaust air suspension enhances low rear climb angles
- Full width gooseneck with 3 to 1 slope to accommodate most rollers





## BLACKHAWK

### • Jeep Dollies

Tow a variety of commercial and construction equipment with ease with Etnyre's jeep dolly series. Our jeep dollies come in 55-ton and up capacities and perform well in even the most aggressive work environments.

Etnyre's jeep dolly series offers customers safe and efficient transportation in 60-to 75-ton capacities.



### FEATURES

- 55-ton and up capacities for hauling a wide-range of equipment
- Triple and tandem axle options available for optimal weight distribution
- Adjustable trailer configurations to meet load requirements
- Ridewell air suspension offers a smooth ride in any environment

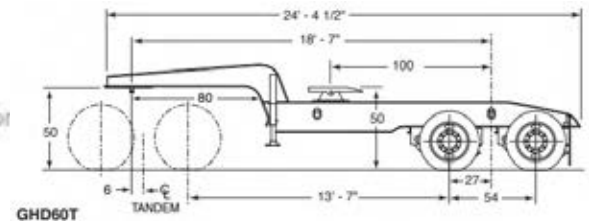

### • Specialty Trailers

Etnyre is committed to your success, which is why we offer a variety of specialized solutions with our custom Blackhawk® trailers. From folding and fixed goosenecks to spread axle trailers, we customize each unit to suit your specific transportation requirements. It's the Etnyre way.



### FEATURES

- 30- to 60-ton capacity for efficient hauling
- Mechanical and hydraulic removable goosenecks for use with any truck
- Outside hydraulic controls for easy operation
- High lift gooseneck for additional road clearance
- Load carrying rear ramp for simplified ground or dock loading
- Hydraulic lift dolly for easy lifting and extending



As simple as they seem, trailers are a highly thought-out piece of equipment utilizing high-tech manufacturing processes, materials, and designs. Taking it one step further, they also must look as good as they perform. These are the reasons others seem to always compare themselves to Towmaster.

### • Drop-Deck

Drop-Deck trailers have the deck between the wheels and feature a lower deck height, lower loading angles, and ladder-style ramps. The Towmaster® T-series large drop-deck trailer is designed for hauling larger mid-sized equipment. This model is built on a stout cold-formed I-beam tongue and main frame and features a 3-inch lip around the deck.



T-10P



T-10D



T-3DT



T-5DT

### • Drop-Deck Tilt

The Towmaster® drop-deck tilt trailers are popular with rental dealers and small contractors. There are no ramps to hassle with; simply tilt the deck and drive on or off. This trailer is built on our cold-formed I-beam tongue and main frame for tough durability.

### • Hydraulic Dump

Our hydraulic dump trailers are perfect for hauling your skid-loader to the job site, carrying dirt, sand or debris, then hauling your skid-loader back home. Towmaster's T-HD trailers feature a power-up/gravity-down hydraulic hoist, stake pockets and D-ring tie-downs, three-way double doors rear gate, and storable ramps. Tarp securement rods are standard. A poly box houses the self-contained hydraulic system; power from the vehicle is not required. Pallet fork holders and other options available.



T-12HD



- **Deck-Over**

Deck-Over trailer decks are over the wheels and feature wider load capabilities, ladder-style ramps, and larger capacities. The premium line of Towmaster® deck-over trailers has proven to offer durability, longevity and style that other brands try to emulate. Our build quality and design creates a trailer that is easy to own and easy to maintain.



T-50 / T-50LP



TC-18-3

- **Deck-Over Tilt**

Deck-Over Tilt trailer decks are over the wheels, and they tilt for loading and unloading. Towmaster's® deck-over air-tilt trailers offer convenience and easy loading by tilting the bed using air from the tow vehicle's system. This provides a clean and efficient way of tilting the deck without the use of hydraulics.



T-24TA / T-40TA / T-50TA



T-20T / T-24T

- **Hydraulic Tail**

Hydraulic Tail trailers are rigid gooseneck type trailers that also feature a rear ramp section that hydraulically lifts and lowers for loading equipment. These trailers feature a lower loading angle and can accommodate many pieces of equipment. The T-70HT, 80HT, and T-110HT trailers by Towmaster are designed for the rental and construction industries. They feature a perimeter frame design, a fifth-wheel gooseneck with top deck, hydraulic folding tail, and 12,000 lb. winch. LED lights, oak wood deck, hi-tensile fabricated steel beam frame, dual parking jacks, and driver side controls are also standard. Several configurations and options are available.



T-70HT / T-80HT / T-110HT

Available Deck Lengths  
43' to 48' (overall lengths)



## • Detachable Gooseneck

Detachable Gooseneck trailers (sometimes referred to as “lowboys”) feature a king-pin gooseneck that stays attached to the tractor truck and detaches from the main trailer deck, providing a means to load and unload large equipment.

The Towmaster® detachable gooseneck trailers are a state-of-the-art design with modular frame construction. This detachable gooseneck trailer offers more convenient features to make loading or unloading quick and easy. The fit and finish is unmatched as the entire trailer is pre-painted before assembly and decking for a professional, clean look. The Towmaster detachable is completely designed and built at our factory, so you can be sure you are getting a genuine quality Towmaster Trailer.



T-120DTG



T-110DTG

Model	Gross Vehicle Weight Rating (lbs)	Trailer Weight (lbs)	Overall Length (ft)
T-70DTG	70,000	14500	42
T-100DTG	100,000	18300	48
T-110DTG	110,000	18700	49.10
T-120DTG	120,000	19500	50.10

## • Rigid Gooseneck

Rigid Gooseneck trailers have the deck over the wheels and include a fifth-wheel king pin type hookup. The Towmaster® T-50RG and T-70RG Rigid Gooseneck trailers are ready to haul your heavy equipment behind your fifth-wheel tractor. They feature dual axles, two-way spring-assist ramps, Hutchens suspension and sealed wiring.



T-50RG / T-70RG

Model	Gross Vehicle Weight Rating (lbs)	Trailer Weight (lbs)	Overall Length (ft)
T-50RG	61,500	11500	39.9
T-70RG	85,600	15600	39.9

## • Galvanizing

Unlike paint, galvanizing creates a metallurgical bond with the steel that forms several layers. These layers protect the steel from rust corrosion and rust seepage in ways paint simply cannot. Some of these formed layers are harder than the steel itself creating an abrasion resistance to help prevent wear from gravel or sand. Galvanizing can also add to the resale value of the trailer and the initial investment is similar to what it would cost to repaint a trailer a few years down the road.

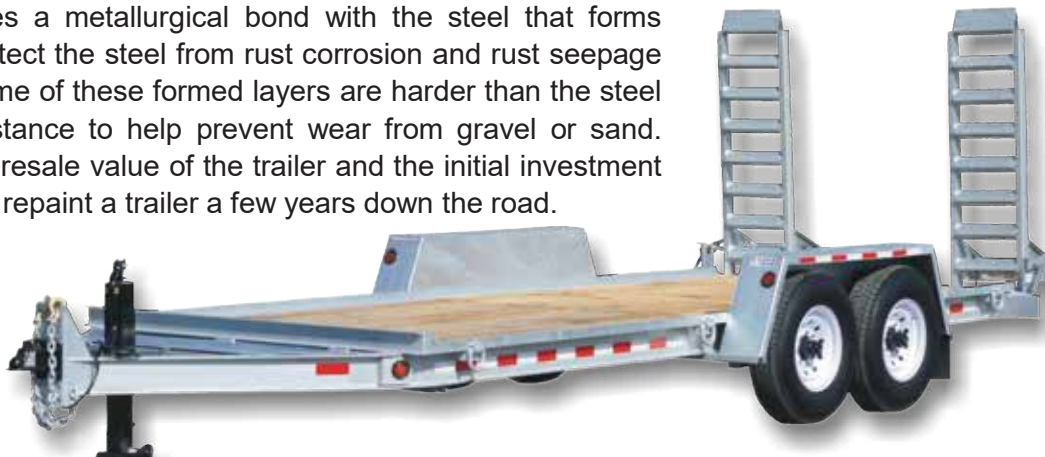

### Available On:

Most models (not lowboys)  
Call for availability

Before any manufacturing begins, every trailer undergoes a strict design review with our Engineering Team. Whether it is one of our 24 unique trailer styles or a custom trailer that we have built for your specific application you can be certain that your trailer is going to be one of the best engineered products in the industry

To begin the construction phase, beams and cross-members are cut to each trailer's specifications. Many of our components are cut by our Hankwang laser table to ensure accurate & repeatable quality for every trailer. For fabricated beams we use the laser table to cut the web and the flange of each beam, then fused together with Felling's Custom Buggo Side Beam Motion System (Beam Welder).

### • Commercial Transport Trailers

Felling has been proudly serving the Commercial Transport Trailer Industry for over 30 years. Felling's ability to design trailers to user's specification has made them the leader in filling the void for many commercial fleets. From various deck lengths to multiple options...Talk with Felling, The Trailer EXPERTS.

#### OTR Over-The-Road Series – (From 35 to 50 Ton.)

Felling's OTR Series (Over The Road) trailers deliver superior performance for the most discerning long-distance commercial carrier. These premium quality commercial transport trailers are specifically designed to meet the demands of the commercial, over-the-road driver, providing superior quality and performance.



#### HX – High Flat Series – (From 35 to 50 Ton.)

Felling's HX Models (High Flats) fill the need where other manufacturers won't. From special deck lengths to custom transport configurations, we have the trailer to meet your hauling needs.

#### X-FORCE Hydraulic Detachable Gooseneck Series – (From 35 to 60 Ton.)

Felling's X-FORCE HDG models have been called one of the "Industry's Most User-Friendly Detaches" when it comes to commercial transport trailers. Standard with the features you want and built with any options you may need.



#### Hydraulic Tail Series – (From 35 to 50 Ton.)

This PERIMETER FRAME / HYD. TAIL model line is popular in many industries such as Commercial Transport, Rental, and Construction for its low load angle and its ability of dock loading. Standard with an 8' 6" hydraulic tail with a 4' fold under tail.

#### Tilt Slide Axle Series – (From 35 to 50 Ton.)

Felling's Slide Axle Tilt trailers are equipped standard with the following key features:

- (6) 5" Rollers, (2) V-rollers and Pad Hydraulic Sliding Axle System
- Scrapers located in front of Rollers
- 4.5" Dual Ram Slide Axle Cylinder
- Knife Edge Approach with Chain Slots





### • Construction Trailers

Felling's diverse Construction Trailers product line is the answer for many company's and contractor's needs. With trailers ranging from the smaller side such as our 3,000 lb. Light Utility Trailers to the larger side such as our 120,000 lb. Heavy Haul Application Trailers, Felling is the key solution for your hauling needs.

No matter what you are hauling, we have the trailer to meet your needs. From lawn mowers to skid steers, to backhoes, to pavers, Felling has the trailer and the features to make your journey from the worksite to the highway a smooth one.

#### Deck-Over Tag Trailers

We know that you work hard and expect your equipment to do the same and then some. That's why we have designed and engineered our Deckover Equipment Trailers with the strength and durability to get the job done day after day. Offering Medium to Heavy Duty Low Profile Deckover tagalong trailers, Felling has the right flatbed trailer for your equipment hauling needs.



Tilt Models



Ramp Models



MX Series



RGT Semi Tilt Series

#### Semi Trailer Lines

Felling has been manufacturing Construction Semi Trailers for over 25 years. Through that time we have designed and engineered a diverse model line offering that caters to the needs of equipment haulers. These lines are an ideal fit for transporting construction, agricultural, and industrial machinery.

#### Drop-Deck Trailer

Also known as a "Deck Between the Wheels" or a "Skid Loader Trailer" is a smaller capacity trailer designed to carry smaller compact equipment like a scissor lift or skid loader. Drop Deck Trailers can be equipped with various ramp options or with a deck tilt feature.

Ramp Model - E Series



Drop Deck



Side Dump

#### Hydraulic Dump Trailer Lines

Also called a "Dump Box Trailer" come in various sizes. They can be designed to haul a small load of dirt or hauling your equipment to and from the job site. No matter the application we have the right dump trailer to get the work done. Felling Dump trailers are utilized in a variety of industries from landscaping, rental yards, commercial hardscaping, constructions sites big and small. Talk to your Felling Salesperson today to get a Felling Dump trailer fitted to your needs.

### • Utility & Telecom Trailers

Felling's Utility & Telecom Division provides trailer solutions for a broad customer base that includes major and regional electric, natural gas, water, and telecommunication companies. From standard models to custom designs, the end result is a trailer that meets your needs.

#### Utility Cable Reel Series Trailers

Felling's Utility Cable Reel trailers are built to your specifications. From our standard single reel configurations to multi-reel trailers, we strive to meet your needs.

- Capacities available from 1,890 lbs. to 14,000 lbs.



#### Pipe Coil Series Trailers

Specifically designed for use in the gas and water sectors, Felling's Pipe Coil trailers are built to high standards and your specifications.

- Capacities available from 1,800 to 6,000 lbs.



#### Utility Pole Trailers

Felling's has been manufacturing Utility Pole trailers for the Utility/Telecom Industry for over 40 years and we know each user has specific needs for their application. Each trailer starts with a base model and is then customized to the customer's needs.

- Capacities available from 4,200 to 24,000 lbs.



### • Generator/ Compressor Trailers

Designed to provide maximum safety and performance at normal highway speeds on and off road. Each model is built to the specifications of the cargo it will be transporting. Show us your plans and we will put them in motion for you.

- Capacities range from 3,500 to 20,000 lbs.

Each Generator / Compressor trailer is built to spec to fit its unique application. From securement location to fuel tank capacity and placement, each unit is engineered for your Genset. Talk with Felling, your Trailer Experts.

#### Popular Options:

- Fuel Tank 50 to 400 gallons
- Toolbox, Jack & Lug Wrench
- Spare Tire Mounted
- Cable Box w/Locking Cover
- Hydraulic Surge Brakes
- Parking Brake
- Wheel Chocks w/Storage
- Front Stabilizer Jacks
- More Options Available



### • Frame Trailers / Tender Trailers

The TENDER / FRAME is another example of our commitment to supplying the trailer market with the highest quality towing products for almost any application! Our Tender/Frame Trailers are engineered to the necessary specifications for the load it will be carrying.

Felling's Frame Trailers / Tender Trailers are designed specifically for your needs, from mounting grain tenders, industrial generators, cement mixers, to cryogenic fuel transport systems. These frame trailers are engineered to your specifications to ensure proper transport of the units that are to be mounted.

- Capacities range from 14,000 to 100,000 lbs.



### • Custom Trailer

Felling's Custom Trailer Division will take your conceptual ideas and turn them into a tangible reality.

Do you have an idea or a rough sketch but not sure where to go from there?

You are in the right place; our Team will take you from the starting point and build on your needs to create a proto-type. We employ a fully staffed Engineering department that utilizes the latest in industry leading design programs. Our Engineers and Designers work along side our highly experienced Metal Craftsmen to create a custom fit to your specific transport needs. We are a teamwork focused company, from the sales to finishing, we focused on building it your way.



FT-12 WD



FT-15 E



FT-14 DT HD with  
cable reel inserts



FT-12 I  
Multi-reel

### • Custom Paint

At Felling we take great measures to ensure a high-quality paint finish is applied to your trailer and we back it with a 3-year warranty.

Felling Trailers, Inc. uses PPG's paint system on its trailers. PPG paint products consist of a two-component polyurethane technology designed to optimize field performance and meet or exceed current environmental regulations. One of the most important qualities of a steel trailer is the preparation it receives before painting and the quality of primer and paint. All materials used in the production of Felling Trailers, are of the highest quality commercially available. Call for Paint Color availability.



Ruby Red Metallic



Sublime Green



Plum Crazy Purple Metallic

The Interstate Line of trailers provides all your transportation needs. Our full line can transport from 4 tons to 50 tons of equipment. Built to last, Interstate trailers are built with High Tensile continuous main beams and interlocking crossmembers. The trailers are designed to ease the problems of loading and unloading, with our versatile ramp configuration. The EASY O'BACK ramp spring makes raising or lifting the ramps almost effortless.

## • Goosenecks

PHT Powertail trailers are available in 35-50 tons and come standard with a 12K winch, 14-degree load angle air ride suspension and 35" loaded deck height.



## • Lowboys

Detachable neck lowboys available from 35 to 60-ton capacity. True 4 beam constructions, apitong decking and air ride suspension standard. air lift 3rd axle and 13 HP Honda powerpack optional.

## • Tagalong Trailers

RBS trailers have an 83" load width and range in capacity from 6 ton to 9 ton. Dexter torflex axles are standard throughout.



Our BST/S models are perfectly suited for directional boring machines and similar. Capacities range from 6 ton to 10 ton.



## • Tagalong Trailers

TDT/TDA trailers are our medium duty tilts available in 10 ton or 12-ton capacities. 4' stationary deck is also available and recommended for hauling backhoes and similar.



TDL tilt trailers are available in 15 to 25 ton capacity and feature dual tilt cylinders, standard 4' stationary deck and available air operated bed lock. NHTSA approved underride is also standard.



Our products serve the construction, commercial, agriculture, wind energy, oil and gas and custom transportation markets. A market-leading manufacturer of heavy haul and specialized trailers, XL offers superior hauling solutions to fit any application.

XL Specialized Trailers was founded in 1995 by George Wall. The original plant was located in Oelwein, Iowa. In 2006, a facility was added in Manchester, Iowa. The Manchester plant serves as XL's headquarters today. In 2016, XL was purchased by Caparo Bull Moose. Our dedicated and skilled staff at XL, combined with a growing dealer network continue to move the company forward.

## • Hyd. Detachable Gooseneck Lowboy

Are you facing the ongoing challenge presented by construction equipment getting bigger, heavier and more varied? The XL Hydraulic Detachable Gooseneck Lowboy Trailer is built distinctively to handle the heaviest construction equipment with ease.

- Versatility through the many different axle configurations available.
- Main deck available in many, lengths, widths and heights.
- Hydraulic neck is wider and stronger than the industry standard offering increased stability for high center of gravity loads.
- Hydraulic support arm contacts truck frames rails only; there is no need to carry a 4 x 4 for blocking the neck.
- XL's new premium paint process, featuring sandblasting, includes a full 1 year warranty.
- D.O.T. approved 12V sealed Grote harness with 7 year warranty.
- Always striving to surpass market standards, all new XL products feature a 5 year structural warranty
- XL's one piece construction results in stronger products. Trailer I-beams are made from one piece web and flange and then welded on all sides.

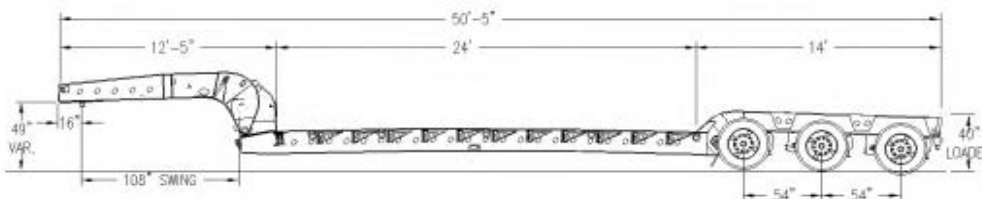

**XL110HDG**  
CAPACITY: 110,000 LB OVERALL  
CONCENTRATED: 110,000 LB IN 10'  
OAL: 50' 5" | OAW: 102"





## • XL 80 Power Tail

With a load angle of 10 degrees, the hydraulic tail is equipped to easily handle hard- to-load equipment such as man lifts, rollers, forklifts and paving equipment. The tail features a lifting capacity of 25,000 pounds for loads centered on the main platform.

- Planetary drive 18,000 lb. hydraulic winch with 75' of 1/2" cable and an air kick out.
- A 9' pop-up ramp from deck to neck allows for easy loading onto the neck.
- Work light at rear of the gooseneck for loading and unloading in the dark.
- A foot hole and grab handle on each side of the gooseneck assist in climbing onto the deck.
- A 2-function wireless remote comes standard, other remote options are available.
- Tail hinge points stay clean thanks to lug style hinges. These hinges prevent debris from accumulating.
- The tail is comprised of two sections – an 8-foot 8-inch platform ramp and a 60-inch flip tail.



## • XL 80 Slide Axle

The XL Slider uses a new approach and innovative technology developed by XL engineers to haul equipment. The XL Slider trailer features an extended dump angle and improved hydraulics to keep your equipment from unnecessary wear.

- 17 degree dump angle for unloading containers with ease.
- Single 2 stage cylinder provides maximum travel and minimal maintenance.
- Pivoting 5th wheel plate.
- Winch at the front for loading inoperable equipment.
- Hydraulic sliding axle assembly with traveling bumper for under ride protection.
- Automatic slack adjusters.
- XL's new premium paint process, featuring sandblasting, includes a full 1 year warranty.

### FEATURES:

- Save time with the quick moving sliding axle assembly
- 6 1/2-degree load angle for loading pavers & rollers
- Versions available with lengths of 48', 51' and 53'
- California legal and R-tac legal specs available
- Chain drops down the outer and inner beams
- 20,000 lb winch with 100' of 9/16" cable
- Front winch pulls inoperable equipment





## • Product Support / Parts

Our parts availability is one of the reasons the products we represent offer a greater value to our customers. Kelly Tractor Co. inventories over 45,000 line items and provides at least 84% parts availability off the shelf. This inventory includes complete engines, transmissions and other major components. In addition, we stock parts for most major brands of lift trucks.

## • Product Support / Service

- Preventative Maintenance Services – field and shop
- 7 Convenient locations – **Miami, Davie, West Palm Beach, Clewiston, Fort Myers, Mulberry, and Orlando**
- Emergency parts network 24 hours a day
- Qualified service technicians
- Technicians on call after hours for emergency services
- Hydraulic hoses and fitting supplies
- Hydraulic test benches
- Exchange components available
  - o Engines
    - Transmissions
    - Hydraulic Cylinders
    - Torque converters
    - Final drives
- Large parts inventory
- Technical analysis inspections
- Dynamometer
- Specialized shops
- Special diagnostic tools
- Repair options
- Caterpillar remanufactured components
- Bucket/Ground Engaging Tools inspections
- Certified machine rebuild options
- Condition Monitoring
  - Vision Link – Web based machine location, health, fuel consumption, and hours etc.
  - SOS – Scheduled oil sampling
  - Web based SOS results
  - Machine inspections (TA1 and TA2)







## USED EQUIPMENT

Our used equipment sales representatives can assist you in selecting the right machine from our inventory. Many of our low hour, late model CAT® machines are from our own rental fleets, where they are maintained by trained technicians. We also carry some competitive lines.

Whether you are right around the corner or around the world, our representative can coordinate the delivery of your used equipment purchase right to your doorstep.

## CAT® CERTIFIED USED EQUIPMENT Inspected, Guaranteed And Ready For Work

Bringing a lightly used machine up to the standards of a Cat Certified Used machine ensures you get maximum value. To help your dollar go further, the process starts with a thorough inspection.

To bring a machine up to our high standards, Cat dealers and their service technicians perform a rigorous, head-to-toe inspection of every eligible machine.

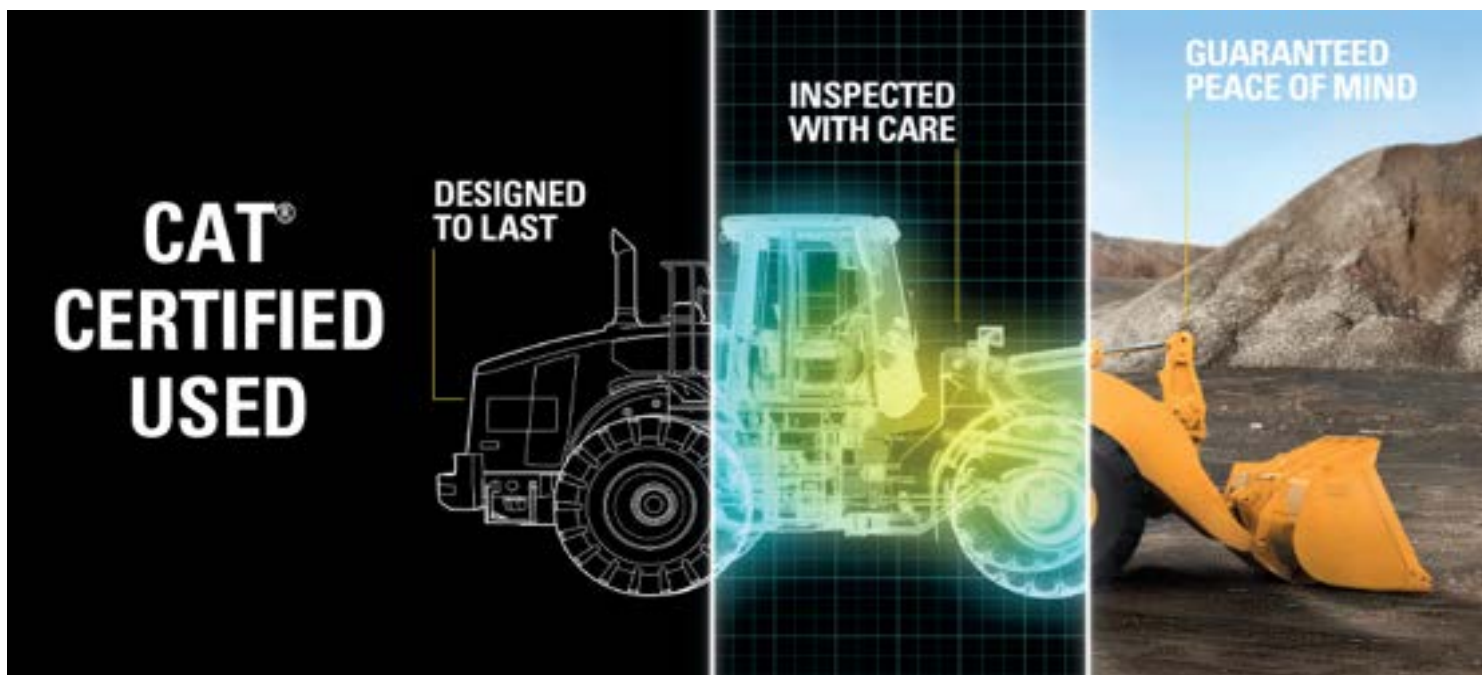

For more information, please contact the used equipment sales department at (305) 592-0556 or e-mail us at [KellyUsedEquipment@KellyTractor.com](mailto:KellyUsedEquipment@KellyTractor.com)



**Ludwig Taveras Perdomo**  
Global Sales  
(Se habla Español)  
[ludwig\\_taverasperdomo@kellytractor.com](mailto:ludwig_taverasperdomo@kellytractor.com)  
Cell: 305-970-5590  
Direct: 305-423-0053  
Fax: 305-477-2024



**Christopher Alvarez**  
Global Sales  
(Se habla Español)  
[Christopher\\_Alvarez@kellytractor.com](mailto:Christopher_Alvarez@kellytractor.com)  
Cell: 786-400-9014  
Direct: 305-423-0053  
Fax: 305-463-6063

How did you hear about us?  Sales Rep  Yellow Pages  Mailer  Ad  Website  Other \_\_\_\_\_

## APPLICATION FOR CREDIT

Date: \_\_\_\_\_

Return to via email to:

KtcMiaCreditDepartment@kellytractor.com

**DO NOT USE PENCIL**

Salesman: \_\_\_\_\_

Attn: Credit Department

THE FOLLOWING INFORMATION IS SUBMITTED AS A BASIS FOR EXTENSION OF CREDIT BY KELLY TRACTOR CO. ITS DIVISIONS AND AFFILIATES (ALL HEREINAFTER JOINTLY AND SEVERALLY REFERRED TO AS KELLY TRACTOR CO.):

1. Legal name of business \_\_\_\_\_  
Type of business \_\_\_\_\_  
Year Established \_\_\_\_\_  Corporation  Partnership  LLC  Single Owner  
Federal ID # \_\_\_\_\_ A/P E-mail: \_\_\_\_\_  
Established under the laws of the State of \_\_\_\_\_ Country \_\_\_\_\_  
If exporting, which country is primary destination? \_\_\_\_\_
2. Business Address: Number \_\_\_\_\_  
City \_\_\_\_\_ State \_\_\_\_\_ Zip \_\_\_\_\_  
Country \_\_\_\_\_  
Mailing Address: Number \_\_\_\_\_  
(if different) City \_\_\_\_\_ State \_\_\_\_\_ Zip \_\_\_\_\_  
Country \_\_\_\_\_ Attn: \_\_\_\_\_  
Business Telephone: Area Code ( ) \_\_\_\_\_ Fax: \_\_\_\_\_
3. Please list Owners, Partners, Officers, and or Primary Stockholders: (Required)  

Name	S.S. #	Home Address	Title
_____	_____	_____	_____
_____	_____	_____	_____
4. Expected monthly credit requirements: \_\_\_\_\_  
(In order to induce credit extension in excess of US \$10,000 a financial statement must accompany this Application. Applicant swears or affirms that the information contained therein is true and correct and applicant agrees to furnish annual financial statements.)
- 5a. Commercial bank references:  
Name of Bank \_\_\_\_\_ Telephone No. \_\_\_\_\_  
Address \_\_\_\_\_ City \_\_\_\_\_ State \_\_\_\_\_ Zip \_\_\_\_\_  
Checking Account? Yes  No  Account No. \_\_\_\_\_  
Loan Experience? Yes  No  Name of Officer to contact: \_\_\_\_\_
- 5b. Trade References:  
Company \_\_\_\_\_ Telephone No. \_\_\_\_\_  
Address \_\_\_\_\_ Acct. # \_\_\_\_\_  
Company \_\_\_\_\_ Telephone No. \_\_\_\_\_  
Address \_\_\_\_\_ Acct. # \_\_\_\_\_  
Company \_\_\_\_\_ Telephone No. \_\_\_\_\_  
Address \_\_\_\_\_ Acct. # \_\_\_\_\_
6. If bonded please provide: Name of Bonding Co. \_\_\_\_\_ Phone \_\_\_\_\_  
Address \_\_\_\_\_
7. Purchase order required? Yes  No  Please list any special invoice instructions.  
\_\_\_\_\_
8. NOTICE: Applicant and each other person signing on the reverse side warrants that the information provided herein or in connection with this application is true and correct and authorizes the release of such information to any party who may provide credit to applicant, whether herein or pursuant to a subsequent application or request, to obtain from banks, credit bureaus and other creditors, all of which are hereby authorized to release, any credit/financial information concerning applicant or such other person (including personal credit bureaus) as such party may deem appropriate, and to share all such information with the other.

9. As partial consideration for the extension of credit, the undersigned agree to the following terms:

All charges incurred during any month are due and payable net 30 days from invoice date. In case payment is not made as specified, a service charge of 1.5% per month on the past due balances is authorized to be added to the amount due KELLY TRACTOR CO.

It is agreed that any claims for shortages will be made in writing within five days after shipment, and claims based on defective material of workmanship will be made in writing within fifteen days after invoice date.

In the event if becomes necessary to place the account with an attorney for collection, we agree to pay all costs of collection, including attorney fees and hereby waive our privilege of being sued in the county of our residence and agree that suit may be brought in Dade or Broward County, Florida USA.

KELLY TRACTOR CO. is not hereby committed to extend any credit whatsoever. If credit is extended KELLY TRACTOR CO. is hereby authorized and directed to continue or discontinue with or without notice, in its sole discretion, such line of credit in any amount or amounts determined by KELLY TRACTOR CO. in its sole discretion or with or without notice to place this amount on a COD basis and/or refuse sales entirely.

Should KELLY TRACTOR CO. ever, because of default, be obliged to institute any proceeding in replevin against us, we hereby waive the notice pertaining thereto in accordance with F.S. 78.067.

We agree to immediately notify KELLY TRACTOR CO. in writing at the above address of any change in ownership or form of our business. This instrument shall remain in full force and effect even after a change of ownership of form of business until actual written notice of revocation is received by KELLY TRACTOR CO. at the address on front of the application.

10. We understand that KELLY TRACTOR CO. is not and will not be liable for indirect, special, incidental, consequential or other damages of any kind, no matter what cause. (SOME STATES DO NOT ALLOW THE EXCLUSION OF INCIDENTAL OF CONSEQUENTIAL DAMAGES, SO THIS EXCLUSION MAY NOT APPLY TO US.) This exclusion will not affect our rights, if any, against others than KELLY TRACTOR CO. including the manufacturer of any parts or equipment sold, used, or furnished by KELLY TRACTOR CO. Any oral agreement, statement, representation, or discussion to the contrary, not withstanding KELLY TRACTOR CO. in any and all past, present, or future dealings with us excludes any and all IMPLIED WARRANTIES OF ANY TYPE INCLUDING ANY IMPLIED WARRANTY OF MERCHANTABILITY AND/OR FITNESS FOR A PARTICULAR PURPOSE.

Notwithstanding any corporate title listed below, the person(s) executing this Credit Application on behalf of the applicant personally, individually and jointly and severally guaranties payment of applicant's past, present, and future obligation to KELLY TRACTOR CO.

DATE: \_\_\_\_\_ NAME: \_\_\_\_\_  
SIGNED: \_\_\_\_\_

**PERSONAL GUARANTEE AND WITNESSED (REQUIRED)**

FOR VALUABLE CONSIDERATION, the receipt of which is hereby acknowledged, the undersigned (hereinafter called "GUARANTORS"), hereby jointly and severally personally guarantee in their individual capacity to pay in full, without reservation, all of the accounts, charges, liabilities, obligations, and/or debts due to become due to KELLY TRACTOR CO. incurred by \_\_\_\_\_

(Hereinafter referred to as "THE FIRM") as Legal name of business on line #1, in accordance with the terms and conditions set forth in this Application as may or have accrued either before or after the execution of this Application until such time as actual written notice of revocation has been received by KELLY TRACTOR CO. is hereby authorized to give THE FIRM, and GUARANTORS unconditionally personally guarantee payment of any amount of credit, and varying amounts of credit at different times above or below any initial credit limit as may be established by KELLY TRACTOR CO. as a result of this application. This Personal Guarantee shall remain in full force and effect even after the firm has changed ownership or form of its business. This is a continuing guarantee. KELLY TRACTOR CO. is not hereby committed to give credit or to continue credit once given to, THE FIRM.

GUARANTORS agree to pay reasonable attorney's fees and all other costs and expenses which may be incurred by KELLY TRACTOR CO. in the enforcement of this Guarantee. The obligation of the undersigned hereunder are joint and several and are independent of the obligations of THE FIRM. A separate action may be brought and prosecuted against GUARANTORS, or any of them, whether an action is brought against THE FIRM or whether THE FIRM be joined in any such action or actions. GUARANTORS waive the benefit of any statute of limitations affecting their liability hereunder or the enforcement thereof. GUARANTORS waive notice of all defaults, and hereby waive our privilege of being sued in the county of our residence and agree that suit may be brought in Miami-Dade County, FL, USA. If there is but a single GUARANTOR, then all words used herein in the plural shall be deemed to have been used in the singular, where the context and the construction so require; and if this Guarantee is executed by more than one GUARANTOR, the word "GUARANTORS" shall mean all and any one or more of them. This Guarantee shall insure to the benefit of KELLY TRACTOR CO. its successors and assigns, and shall be binding upon the heirs, personal representatives, successors and assigns of each of the GUARANTORS. GUARANTORS shall not assign this Guarantee without the prior consent of KELLY TRACTOR CO.

IN WITNESS HEREOF, each of the undersigned has duly executed this Guarantee this \_\_\_\_\_ day of \_\_\_\_\_, 20\_\_\_\_\_

"Guarantor" Signature X \_\_\_\_\_ "Guarantor" Signature X \_\_\_\_\_

Name (Print) \_\_\_\_\_ Name (Print) \_\_\_\_\_

Residence address: \_\_\_\_\_ Residence address: \_\_\_\_\_

Telephone # \_\_\_\_\_ SS# \_\_\_\_\_ Telephone # \_\_\_\_\_ SS# \_\_\_\_\_

Dr. Lic. # \_\_\_\_\_ State \_\_\_\_\_ Dr. Lic. # \_\_\_\_\_ State \_\_\_\_\_

Witness: X \_\_\_\_\_ Witness: X \_\_\_\_\_

Name (Print) \_\_\_\_\_ Name (Print) \_\_\_\_\_

Have you filed for bankruptcy in the last 10 years? YES  NO

Have you filed for bankruptcy in the last 10 years? YES  NO

NOTICE: If your application for business credit is denied, you have the right to a written statement of the specific reasons for the denial. To obtain the statement, please contact: The Credit Department 8255 N.W. 58th Street, Miami, FL 33166 within 60 days from the date you are notified of our decision. We will send you a written statement of the reasons for the denial within 30 days from receiving your request. The Federal Equal Credit Opportunity Act prohibits creditors from discriminating against credit applicants on the basis of race, color, religion, national origin, sex, marital status, age (provided the applicant has the capacity to enter into a binding contract); because all or part of the applicant's income derives from any public assistance program; or because the applicant has in good faith exercised any right under the Consumer Credit Protection Act. The federal agency that administers compliance with this law concerning this Lender is the FTC Regional Office for the region in which the Lender operates or the Federal Trade Commission, Equal Credit Opportunity, Washington, DC 20580

# KELLY TRACTOR LOCATIONS

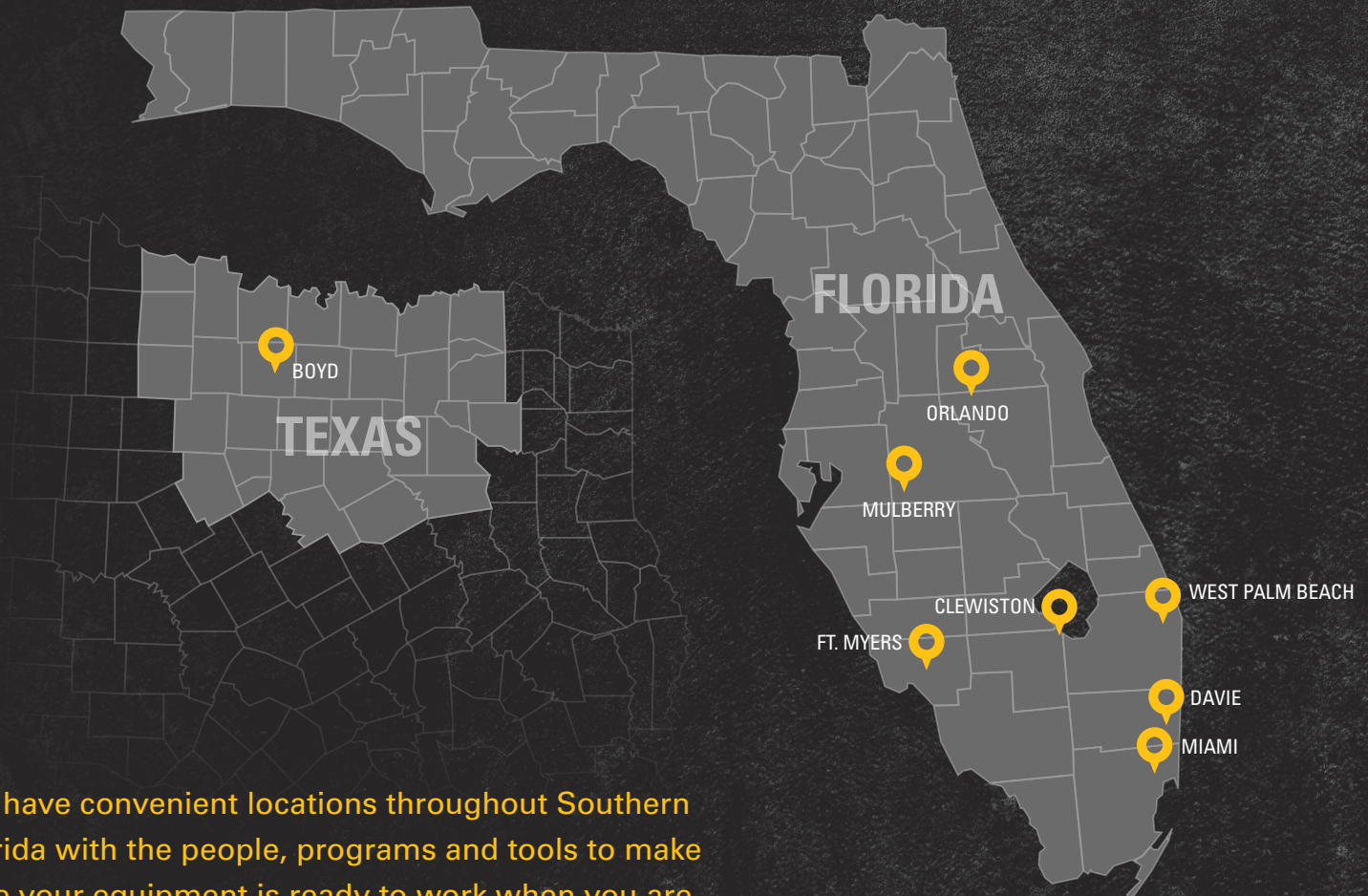

We have convenient locations throughout Southern Florida with the people, programs and tools to make sure your equipment is ready to work when you are.

## MIAMI

8255 NW 58th Street  
Miami, FL 33166  
305-592-5360

## DAVIE

2801 Reese Road  
Davie, FL 33314  
954-581-8181

## WEST PALM BEACH

5460 Okeechobee Boulevard  
West Palm Beach, FL 33417  
561-683-1231

## CLEWISTON

801 East Sugarland Highway  
Clewiston, FL 33440  
863-983-8177

## FT. MYERS

9651 Kelly Tractor Drive  
Ft. Myers FL 33905  
239-693-9233

## MULBERRY

IMT Drills Service and Fabrication  
443 Bradshaw Industrial Parkway  
Mulberry, FL 33860-1318  
863-354-9036

## ORLANDO

Link-Belt Cranes & Massey Ferguson  
144 W. Landstreet Rd.  
Orlando, FL 32824  
407-568-8055

## BOYD, TEXAS

IMT Drill Service & Parts  
370 CR 4576  
Boyd, TX, 76023  
940-287-3740

# 877-794-7102

[www.kellytractor.com](http://www.kellytractor.com)

© 2024 Caterpillar. All Rights Reserved. CAT, CATERPILLAR, LET'S DO THE WORK, their respective logos, "Caterpillar Corporate Yellow", the "Power Edge" and Cat "Modern Hex" trade dress as well as corporate and product identity used herein, are trademarks of Caterpillar and may not be used without permission. [www.cat.com](http://www.cat.com) / [www.caterpillar.com](http://www.caterpillar.com)

**KELLY TRACTOR**

